



Printed 8/14/2022



- 1. White
- 2. Light Blue
- 3. Red
- 4. Silver
- 5. Harvest Gold
- 6. Black

Eo1017-01-4x4.pes
3.87x3.17 inches; 32,293 stitches
6 thread changes; 6 colors



- 1. White
- 2. Light Blue
- 3. Red
- 4. Silver
- 5. Harvest Gold
- 6. Black

Eo1017-01-5x7.pes
6.60x4.88 inches; 63,020 stitches
6 thread changes; 6 colors



- 1. White
- 2. Light Blue
- 3. Red
- 4. Silver
- 5. Harvest Gold
- 6. Black
- 7. Harvest Gold
- 8. Red

Eo1017-01-6x10.pes
9.57x5.91 inches; 91,954 stitches
8 thread changes; 6 colors



- 1. White
- 2. Light Blue
- 3. Red
- 4. Silver
- 5. Harvest Gold
- 6. Black

Eo1017-01-8x12.pes
11.28x6.95 inches; 116,600 stitches
6 thread changes; 6 colors

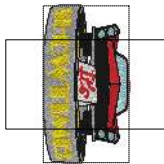

- 1. White
- 2. Light Blue
- 3. Red
- 4. Silver
- 5. Harvest Gold
- 6. Black

Eo1017-01-8x14.pes
7.58x13.83 inches; 145,005 stitches
6 thread changes; 6 colors



- 1. Light Blue
- 2. Silver
- 3. Dark Gray
- 4. Purple
- 5. Black

Eo1017-02-4x4.pes
3.79x3.35 inches; 17,516 stitches
5 thread changes; 5 colors

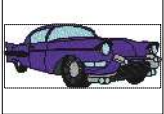

- 1. Light Blue
- 2. Silver
- 3. Dark Gray
- 4. Purple
- 5. Black

Eo1017-02-5x7.pes
6.87x2.80 inches; 34,317 stitches
5 thread changes; 5 colors



- 1. Light Blue
- 2. Silver
- 3. Dark Gray
- 4. Purple
- 5. Black

Eo1017-02-6x10.pes
10.13x4.12 inches; 59,146 stitches
5 thread changes; 5 colors

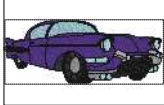

- 1. Light Blue
- 2. Silver
- 3. Dark Gray
- 4. Purple
- 5. Black

Eo1017-02-8x12.pes
11.66x4.74 inches; 72,642 stitches
5 thread changes; 5 colors

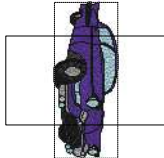

- 1. Light Blue
- 2. Silver
- 3. Dark Gray
- 4. Purple
- 5. Black

Eo1017-02-8x14.pes
5.59x13.74 inches; 93,279 stitches
5 thread changes; 5 colors

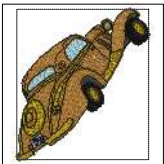

- 1. Dark Gray
- 2. Light Blue
- 3. Light Brown
- 4. Black
- 5. Silver
- 6. Brass
- 7. Black

Eo1017-03-4x4.pes
3.23x3.68 inches; 14,106 stitches
7 thread changes; 6 colors

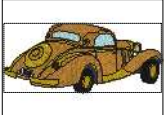

- 1. Dark Gray
- 2. Light Blue
- 3. Light Brown
- 4. Black
- 5. Silver
- 6. Brass
- 7. Black

Eo1017-03-5x7.pes
6.94x3.05 inches; 30,290 stitches
7 thread changes; 6 colors



- 1. Dark Gray
- 2. Light Blue
- 3. Light Brown
- 4. Black
- 5. Silver
- 6. Brass
- 7. Black

Eo1017-03-6x10.pes
9.94x4.31 inches; 50,907 stitches
7 thread changes; 6 colors



- 1. Dark Gray
- 2. Light Blue
- 3. Light Brown
- 4. Black
- 5. Silver
- 6. Brass
- 7. Black

Eo1017-03-8x12.pes
11.71x5.28 inches; 70,057 stitches
7 thread changes; 6 colors

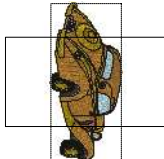

- 1. Dark Gray
- 2. Light Blue
- 3. Light Brown
- 4. Black
- 5. Silver
- 6. Brass
- 7. Black

Eo1017-03-8x14.pes
6.20x13.76 inches; 91,012 stitches
7 thread changes; 6 colors

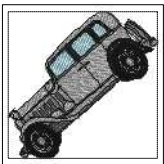

- 1. Light Blue
- 2. Dark Gray
- 3. Silver
- 4. Gray
- 5. White
- 6. Black

Eo1017-04-4x4.pes
3.65x3.59 inches; 18,296 stitches
6 thread changes; 6 colors

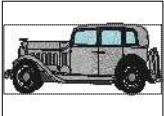

- 1. Light Blue
- 2. Dark Gray
- 3. Silver
- 4. Gray
- 5. White
- 6. Black

Eo1017-04-5x7.pes
6.93x3.06 inches; 38,805 stitches
6 thread changes; 6 colors

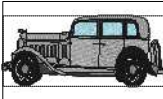

- 1. Light Blue
- 2. Dark Gray
- 3. Silver
- 4. Gray
- 5. White
- 6. Black

Eo1017-04-6x10.pes
10.20x4.50 inches; 66,331 stitches
6 thread changes; 6 colors

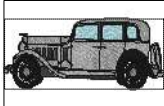

- 1. Light Blue
- 2. Dark Gray
- 3. Silver
- 4. Gray
- 5. White
- 6. Black

Eo1017-04-8x12.pes
11.71x5.16 inches; 80,078 stitches
6 thread changes; 6 colors

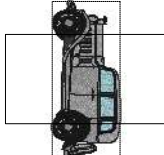

- 1. Light Blue
- 2. Dark Gray
- 3. Silver
- 4. Gray
- 5. White
- 6. Black

Eo1017-04-8x14.pes
6.01x13.65 inches; 99,606 stitches
6 thread changes; 6 colors

CAR SHOWTIME IS A GREATSET OF ANTIQUE AND CLASSIC CARS. PLEASE HOOP AND STABILIZE WELL, LOTS OF FANCY FILLS AND LARGE PATTERNS

D:\OneDrive\00 SEWING AND EMBROIDERY\00 EMERALD ORIGINALS\000 non golden group sets\00000 EO Sets\EO1017-SHOWTIME\EO1017-PES\EO1017-WORKING FOLDER\EO1017-all sizes

Printed 8/14/2022

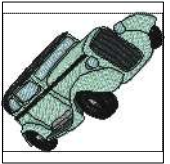

- 1. Light Blue
- 2. Silver
- 3. Dark Gray
- 4. Seacrest
- 5. Black

Eo1017-05-4x4.pes
3.92x3.38 inches; 17,002 stitches
5 thread changes; 5 colors

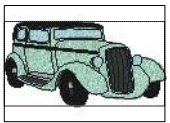

- 1. Light Blue
- 2. Silver
- 3. Dark Gray
- 4. Seacrest
- 5. Black

Eo1017-05-5x7.pes
7.06x3.72 inches; 38,057 stitches
5 thread changes; 5 colors

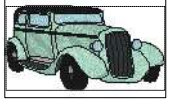

- 1. Light Blue
- 2. Silver
- 3. Dark Gray
- 4. Seacrest
- 5. Black

Eo1017-05-6x10.pes
10.11x5.33 inches; 64,099 stitches
5 thread changes; 5 colors

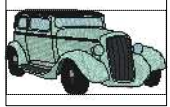

- 1. Light Blue
- 2. Silver
- 3. Dark Gray
- 4. Seacrest
- 5. Black

Eo1017-05-8x12.pes
11.77x6.20 inches; 80,682 stitches
5 thread changes; 5 colors

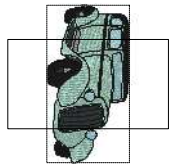

- 1. Light Blue
- 2. Silver
- 3. Dark Gray
- 4. Seacrest
- 5. Black

Eo1017-05-8x14.pes
7.31x13.87 inches; 104,384 stitches
5 thread changes; 5 colors

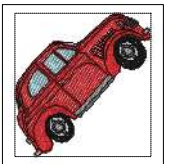

- 1. White
- 2. Light Blue
- 3. Dark Gray
- 4. Silver
- 5. Red
- 6. Black

Eo1017-06-4x4.pes
3.32x3.50 inches; 14,784 stitches
6 thread changes; 6 colors

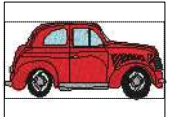

- 1. White
- 2. Light Blue
- 3. Dark Gray
- 4. Silver
- 5. Red
- 6. Black

Eo1017-06-5x7.pes
7.04x3.38 inches; 32,890 stitches
6 thread changes; 6 colors

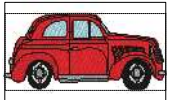

- 1. White
- 2. Light Blue
- 3. Dark Gray
- 4. Silver
- 5. Red
- 6. Black

Eo1017-06-6x10.pes
10.20x4.90 inches; 56,384 stitches
6 thread changes; 6 colors

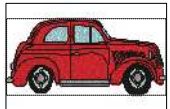

- 1. White
- 2. Light Blue
- 3. Dark Gray
- 4. Silver
- 5. Red
- 6. Black

Eo1017-06-8x12.pes
11.73x5.62 inches; 69,738 stitches
6 thread changes; 6 colors

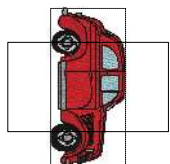

- 1. White
- 2. Light Blue
- 3. Dark Gray
- 4. Silver
- 5. Red
- 6. Black

Eo1017-06-8x14.pes
6.63x13.83 inches; 89,384 stitches
6 thread changes; 6 colors



- 1. Light Blue
- 2. Peacock Blue
- 3. Electric Blue
- 4. Black
- 5. Dark Gray
- 6. Black

Eo1017-07-4x4.pes
3.35x3.53 inches; 13,792 stitches
6 thread changes; 5 colors

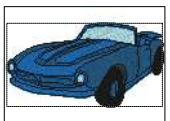

- 1. Light Blue
- 2. Peacock Blue
- 3. Electric Blue
- 4. Black
- 5. Dark Gray
- 6. Black

Eo1017-07-5x7.pes
6.86x3.67 inches; 33,325 stitches
6 thread changes; 5 colors



- 1. Light Blue
- 2. Peacock Blue
- 3. Electric Blue
- 4. Black
- 5. Dark Gray
- 6. Black

Eo1017-07-6x10.pes
9.88x5.28 inches; 57,117 stitches
6 thread changes; 5 colors



- 1. Light Blue
- 2. Peacock Blue
- 3. Electric Blue
- 4. Black
- 5. Dark Gray
- 6. Black

Eo1017-07-8x12.pes
6.06x11.36 inches; 70,786 stitches
6 thread changes; 5 colors

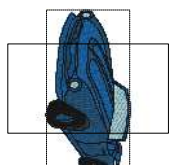

- 1. Light Blue
- 2. Peacock Blue
- 3. Electric Blue
- 4. Black
- 5. Dark Gray
- 6. Black

Eo1017-07-8x14.pes
7.37x13.82 inches; 95,860 stitches
6 thread changes; 5 colors

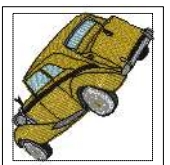

- 1. Light Blue
- 2. Brass
- 3. Silver
- 4. Black
- 5. Dark Gray
- 6. White
- 7. Black
- 8. White

Eo1017-08-4x4.pes
3.42x3.60 inches; 15,406 stitches
8 thread changes; 6 colors

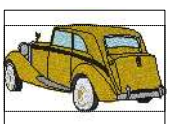

- 1. Light Blue
- 2. Brass
- 3. Silver
- 4. Black
- 5. Dark Gray
- 6. White
- 7. Black
- 8. White

Eo1017-08-5x7.pes
7.07x3.78 inches; 33,990 stitches
8 thread changes; 6 colors

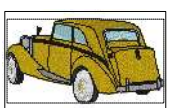

- 1. Light Blue
- 2. Brass
- 3. Silver
- 4. Black
- 5. Dark Gray
- 6. White
- 7. Black
- 8. White

Eo1017-08-6x10.pes
9.98x5.34 inches; 56,481 stitches
8 thread changes; 6 colors

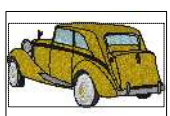

- 1. Light Blue
- 2. Brass
- 3. Silver
- 4. Black
- 5. Dark Gray
- 6. White
- 7. Black
- 8. White

Eo1017-08-8x12.pes
11.46x6.14 inches; 69,541 stitches
8 thread changes; 6 colors

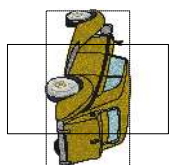

- 1. Light Blue
- 2. Brass
- 3. Silver
- 4. Black
- 5. Dark Gray
- 6. White
- 7. Black
- 8. White

Eo1017-08-8x14.pes
7.37x13.81 inches; 92,823 stitches
8 thread changes; 6 colors

Printed 8/14/2022



- 1. Silver
- 2. Dark Gray
- 3. Deep Gold
- 4. Brass
- 5. Deep Green
- 6. Lime Green
- 7. Black

Eo1017-09-4x4.pes
3.57x3.60 inches; 12,984 stitches
7 thread changes; 7 colors

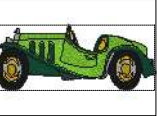

- 1. Light Blue
- 2. Silver
- 3. Dark Gray
- 4. Deep Gold
- 5. Brass
- 6. Deep Green
- 7. Lime Green
- 8. Black

Eo1017-09-5x7.pes
6.97x2.89 inches; 28,111 stitches
8 thread changes; 8 colors

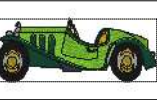

- 1. Light Blue
- 2. Silver
- 3. Dark Gray
- 4. Deep Gold
- 5. Brass
- 6. Deep Green
- 7. Lime Green
- 8. Black

Eo1017-09-6x10.pes
10.11x3.99 inches; 47,165 stitches
8 thread changes; 8 colors

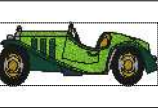

- 1. Light Blue
- 2. Silver
- 3. Dark Gray
- 4. Deep Gold
- 5. Brass
- 6. Deep Green
- 7. Lime Green
- 8. Black

Eo1017-09-8x12.pes
11.75x4.63 inches; 58,684 stitches
8 thread changes; 8 colors



- 1. Light Blue
- 2. Silver
- 3. Dark Gray
- 4. Deep Gold
- 5. Brass
- 6. Deep Green
- 7. Lime Green
- 8. Black

Eo1017-09-8x14.pes
5.39x13.69 inches; 73,500 stitches
8 thread changes; 8 colors

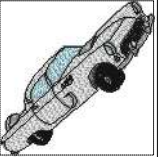

- 1. Light Blue
- 2. Dark Gray
- 3. White
- 4. Silver
- 5. Black

Eo1017-10-4x4.pes
3.76x3.77 inches; 11,970 stitches
5 thread changes; 5 colors

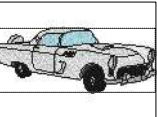

- 1. Light Blue
- 2. Dark Gray
- 3. White
- 4. Silver
- 5. Black

Eo1017-10-5x7.pes
7.02x2.83 inches; 25,057 stitches
5 thread changes; 5 colors

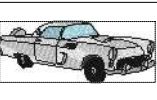

- 1. Light Blue
- 2. Dark Gray
- 3. White
- 4. Silver
- 5. Black

Eo1017-10-6x10.pes
9.91x3.87 inches; 42,707 stitches
5 thread changes; 5 colors



- 1. Light Blue (Bro:17)
- 2. Dark Gray (Bro:707)
- 3. White (Bro:1)
- 4. Silver (Bro:5)
- 5. Black (Bro:900)

Eo1017-10-8x12.pes
11.36x4.54 inches; 55,185 stitches
5 thread changes; 5 colors

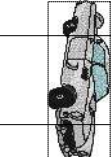

- 1. Light Blue
- 2. Dark Gray
- 3. White
- 4. Silver
- 5. Black

Eo1017-10-8x14.pes
5.50x13.80 inches; 72,243 stitches
5 thread changes; 5 colors



- 1. Light Blue
- 2. Silver
- 3. Blue
- 4. Dark Gray
- 5. White
- 6. Black

Eo1017-11-4x4.pes
3.51x3.69 inches; 12,086 stitches
6 thread changes; 6 colors

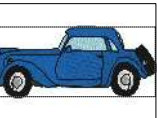

- 1. Light Blue
- 2. Silver
- 3. Blue
- 4. Dark Gray
- 5. White
- 6. Black

Eo1017-11-5x7.pes
7.03x3.09 inches; 26,785 stitches
6 thread changes; 6 colors

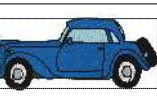

- 1. Light Blue
- 2. Silver
- 3. Blue
- 4. Dark Gray
- 5. White
- 6. Black

Eo1017-11-6x10.pes
10.20x4.46 inches; 47,416 stitches
6 thread changes; 6 colors

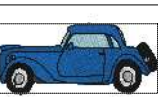

- 1. Light Blue
- 2. Silver
- 3. Blue
- 4. Dark Gray
- 5. White
- 6. Black

Eo1017-11-8x12.pes
11.71x5.13 inches; 59,247 stitches
6 thread changes; 6 colors

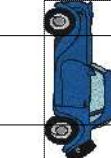

- 1. Light Blue
- 2. Silver
- 3. Blue
- 4. Dark Gray
- 5. White
- 6. Black

Eo1017-11-8x14.pes
6.14x14.05 inches; 79,902 stitches
6 thread changes; 6 colors

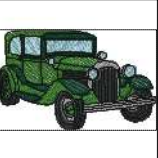

- 1. Light Blue
- 2. Moss Green
- 3. Deep Green
- 4. Dark Gray
- 5. Silver
- 6. Black

Eo1017-12-4x4.pes
3.91x2.46 inches; 20,352 stitches
6 thread changes; 6 colors

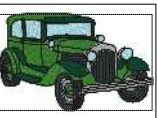

- 1. Light Blue
- 2. Moss Green
- 3. Deep Green
- 4. Dark Gray
- 5. Silver
- 6. Black

Eo1017-12-5x7.pes
6.74x4.24 inches; 42,598 stitches
6 thread changes; 6 colors



- 1. Light Blue
- 2. Moss Green
- 3. Deep Green
- 4. Dark Gray
- 5. Silver
- 6. Black

Eo1017-12-6x10.pes
9.87x5.84 inches; 69,961 stitches
6 thread changes; 6 colors



- 1. Light Blue
- 2. Moss Green
- 3. Deep Green
- 4. Dark Gray
- 5. Silver
- 6. Black

Eo1017-12-8x12.pes
11.33x6.69 inches; 86,313 stitches
6 thread changes; 6 colors

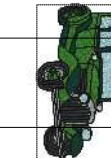

- 1. Light Blue
- 2. Moss Green
- 3. Deep Green
- 4. Dark Gray
- 5. Silver
- 6. Black

Eo1017-12-8x14.pes
7.44x13.72 inches; 107,982 stitches
6 thread changes; 6 colors

Printed 8/14/2022

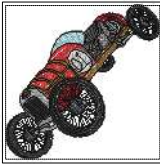

- 1. Light Blue
- 2. Red
- 3. Light Brown
- 4. Dark Gray
- 5. Silver
- 6. White
- 7. Gray
- 8. Black

Eo1017-13-4x4.pes
3.78x3.76 inches; 19,740 stitches
8 thread changes; 8 colors

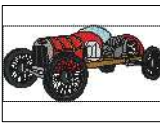

- 1. Light Blue
- 2. Red
- 3. Light Brown
- 4. Dark Gray
- 5. Silver
- 6. White
- 7. Gray
- 8. Black

Eo1017-13-5x7.pes
7.01x3.34 inches; 39,098 stitches
8 thread changes; 8 colors

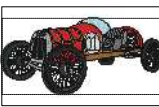

- 1. Light Blue
- 2. Red
- 3. Light Brown
- 4. Dark Gray
- 5. Silver
- 6. White
- 7. Gray
- 8. Black

Eo1017-13-6x10.pes
10.20x4.86 inches; 65,288 stitches
8 thread changes; 8 colors

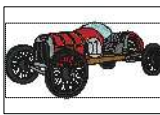

- 1. Light Blue
- 2. Red
- 3. Light Brown
- 4. Dark Gray
- 5. Silver
- 6. White
- 7. Gray
- 8. Black

Eo1017-13-8x12.pes
11.57x5.51 inches; 77,440 stitches
8 thread changes; 8 colors

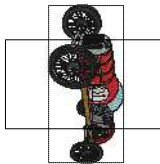

- 1. Light Blue
- 2. Red
- 3. Light Brown
- 4. Dark Gray
- 5. Silver
- 6. White
- 7. Gray
- 8. Black

Eo1017-13-8x14.pes
6.59x13.84 inches; 101,047 stitches
8 thread changes; 8 colors

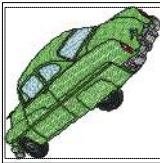

- 1. Light Blue
- 2. Dark Gray
- 3. Silver
- 4. Leaf Green
- 5. Red
- 6. Lime Green
- 7. Black

Eo1017-14-4x4.pes
3.81x3.69 inches; 12,902 stitches
7 thread changes; 7 colors

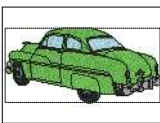

- 1. Light Blue
- 2. Red
- 3. Dark Gray
- 4. Silver
- 5. Leaf Green
- 6. Lime Green
- 7. Black

Eo1017-14-5x7.pes
6.83x3.28 inches; 26,829 stitches
7 thread changes; 7 colors

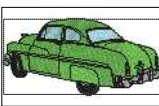

- 1. Light Blue
- 2. Red
- 3. Dark Gray
- 4. Silver
- 5. Leaf Green
- 6. Lime Green
- 7. Black

Eo1017-14-6x10.pes
9.99x4.80 inches; 48,251 stitches
7 thread changes; 7 colors

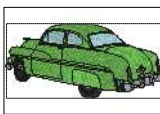

- 1. Light Blue
- 2. Red
- 3. Dark Gray
- 4. Silver
- 5. Leaf Green
- 6. Lime Green
- 7. Black

Eo1017-14-8x12.pes
11.46x5.50 inches; 59,436 stitches
7 thread changes; 7 colors

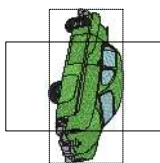

- 1. Light Blue
- 2. Red
- 3. Dark Gray
- 4. Silver
- 5. Leaf Green
- 6. Lime Green
- 7. Black

Eo1017-14-8x14.pes
6.51x13.57 inches; 77,933 stitches
7 thread changes; 7 colors

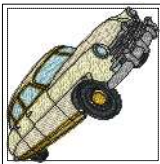

- 1. Light Blue
- 2. Cream Brown
- 3. Beige
- 4. Dark Gray
- 5. Silver
- 6. Deep Gold
- 7. Black

Eo1017-15-4x4.pes
3.69x3.72 inches; 14,415 stitches
7 thread changes; 7 colors

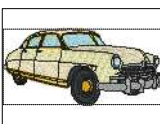

- 1. Light Blue
- 2. Cream Brown
- 3. Beige
- 4. Dark Gray
- 5. Silver
- 6. Deep Gold
- 7. Black

Eo1017-15-5x7.pes
6.98x3.34 inches; 30,264 stitches
7 thread changes; 7 colors



- 1. Light Blue
- 2. Cream Brown
- 3. Beige
- 4. Dark Gray
- 5. Silver
- 6. Deep Gold
- 7. Black

Eo1017-15-6x10.pes
10.22x4.88 inches; 52,744 stitches
7 thread changes; 7 colors



- 1. Light Blue
- 2. Cream Brown
- 3. Beige
- 4. Dark Gray
- 5. Silver
- 6. Deep Gold
- 7. Black

Eo1017-15-8x12.pes
11.50x5.50 inches; 63,309 stitches
7 thread changes; 7 colors

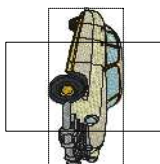

- 1. Light Blue
- 2. Cream Brown
- 3. Beige
- 4. Dark Gray
- 5. Silver
- 6. Deep Gold
- 7. Black

Eo1017-15-8x14.pes
6.59x13.80 inches; 83,590 stitches
7 thread changes; 7 colors

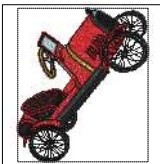

- 1. Light Blue
- 2. Silver
- 3. Dark Gray
- 4. Red
- 5. Light Brown
- 6. Black
- 7. Red

Eo1017-16-4x4.pes
3.18x3.76 inches; 15,361 stitches
7 thread changes; 6 colors

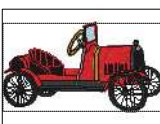

- 1. Light Blue
- 2. Silver
- 3. Dark Gray
- 4. Red
- 5. Light Brown
- 6. Black
- 7. Red

Eo1017-16-5x7.pes
7.01x3.88 inches; 31,406 stitches
7 thread changes; 6 colors

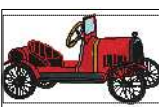

- 1. Light Blue
- 2. Silver
- 3. Dark Gray
- 4. Red
- 5. Light Brown
- 6. Black
- 7. Red

Eo1017-16-6x10.pes
10.10x5.60 inches; 51,705 stitches
7 thread changes; 6 colors



- 1. Light Blue
- 2. Silver
- 3. Dark Gray
- 4. Red
- 5. Light Brown
- 6. Black
- 7. Red

Eo1017-16-8x12.pes
6.50x11.72 inches; 63,683 stitches
7 thread changes; 6 colors

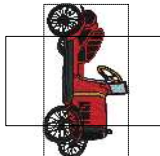

- 1. Light Blue
- 2. Silver
- 3. Dark Gray
- 4. Red
- 5. Light Brown
- 6. Black
- 7. Red

Eo1017-16-8x14.pes
7.47x13.50 inches; 77,892 stitches
7 thread changes; 6 colors