





















This cute child's alpha is adorable and would be so cute decorating a child's room, quilts, pillow cases, curtains etc. even book covers. Lots of fancy fills hoop and stabilize well.

Printed 10/1/2022

 <ul style="list-style-type: none"> ■ 1. Red (Bro:800) ■ 2. Harvest Gold (Bro:206) ■ 3. Leaf Green (Bro:509) ■ 4. Lime Green (Bro:513) ■ 5. Light Brown (Bro:323) ■ 6. Black (Bro:900) <p>Eo1025-01-4x4.pes 3.90x3.83 inches; 17,366 stitches 6 thread changes; 6 colors</p>	 <ul style="list-style-type: none"> ■ 1. Red (Bro:800) ■ 2. Harvest Gold (Bro:206) ■ 3. Leaf Green (Bro:509) ■ 4. Lime Green (Bro:513) ■ 5. Light Brown (Bro:323) ■ 6. Black (Bro:900) <p>Eo1025-01-5x7.pes 6.69x4.93 inches; 29,547 stitches 6 thread changes; 6 colors</p>	 <ul style="list-style-type: none"> ■ 1. Red (Bro:800) ■ 2. Harvest Gold (Bro:206) ■ 3. Leaf Green (Bro:509) ■ 4. Lime Green (Bro:513) ■ 5. Light Brown (Bro:323) ■ 6. Black (Bro:900) <p>Eo1025-01-6x10.pes 9.69x5.96 inches; 44,874 stitches 6 thread changes; 6 colors</p>	 <ul style="list-style-type: none"> ■ 1. Red (Bro:800) ■ 2. Harvest Gold (Bro:206) ■ 3. Leaf Green (Bro:509) ■ 4. Lime Green (Bro:513) ■ 5. Light Brown (Bro:323) ■ 6. Black (Bro:900) <p>Eo1025-01-8x12.pes 11.27x7.31 inches; 59,768 stitches 6 thread changes; 6 colors</p>	 <ul style="list-style-type: none"> ■ 1. Red (Bro:800) ■ 2. Harvest Gold (Bro:206) ■ 3. Leaf Green (Bro:509) ■ 4. Lime Green (Bro:513) ■ 5. Light Brown (Bro:323) ■ 6. Black (Bro:900) <p>Eo1025-01-8x14.pes 13.78x7.31 inches; 69,932 stitches 6 thread changes; 6 colors</p>
 <ul style="list-style-type: none"> ■ 1. Deep Gold (Bro:214) ■ 2. Light Brown (Bro:323) ■ 3. Silver (Bro:5) ■ 4. Black (Bro:900) <p>Eo1025-02-4x4.pes 3.72x3.67 inches; 16,633 stitches 4 thread changes; 4 colors</p>	 <ul style="list-style-type: none"> ■ 1. Deep Gold (Bro:214) ■ 2. Light Brown (Bro:323) ■ 3. Silver (Bro:5) ■ 4. Black (Bro:900) <p>Eo1025-02-5x7.pes 6.63x4.93 inches; 31,140 stitches 4 thread changes; 4 colors</p>	 <ul style="list-style-type: none"> ■ 1. Deep Gold (Bro:214) ■ 2. Light Brown (Bro:323) ■ 3. Silver (Bro:5) ■ 4. Black (Bro:900) <p>Eo1025-02-6x10.pes 9.83x6.05 inches; 50,843 stitches 4 thread changes; 4 colors</p>	 <ul style="list-style-type: none"> ■ 1. Deep Gold (Bro:214) ■ 2. Light Brown (Bro:323) ■ 3. Silver (Bro:5) ■ 4. Black (Bro:900) <p>Eo1025-02-8x12.pes 11.52x7.44 inches; 68,743 stitches 4 thread changes; 4 colors</p>	 <ul style="list-style-type: none"> ■ 1. Deep Gold (Bro:214) ■ 2. Light Brown (Bro:323) ■ 3. Silver (Bro:5) ■ 4. Black (Bro:900) <p>Eo1025-02-8x14.pes 13.87x7.44 inches; 80,327 stitches 4 thread changes; 4 colors</p>
 <ul style="list-style-type: none"> ■ 1. Electric Blue (Bro:420) ■ 2. Light Blue (Bro:17) ■ 3. Prussian Blue (Bro:7) ■ 4. Silver (Bro:5) ■ 5. Black (Bro:900) <p>Eo1025-03-4x4.pes 3.87x3.70 inches; 22,786 stitches 5 thread changes; 5 colors</p>	 <ul style="list-style-type: none"> ■ 1. Electric Blue (Bro:420) ■ 2. Light Blue (Bro:17) ■ 3. Prussian Blue (Bro:7) ■ 4. Silver (Bro:5) ■ 5. Black (Bro:900) <p>Eo1025-03-5x7.pes 7.02x5.04 inches; 43,970 stitches 5 thread changes; 5 colors</p>	 <ul style="list-style-type: none"> ■ 1. Electric Blue (Bro:420) ■ 2. Light Blue (Bro:17) ■ 3. Prussian Blue (Bro:7) ■ 4. Silver (Bro:5) ■ 5. Black (Bro:900) <p>Eo1025-03-6x10.pes 10.00x6.09 inches; 69,397 stitches 5 thread changes; 5 colors</p>	 <ul style="list-style-type: none"> ■ 1. Electric Blue (Bro:420) ■ 2. Light Blue (Bro:17) ■ 3. Prussian Blue (Bro:7) ■ 4. Silver (Bro:5) ■ 5. Black (Bro:900) <p>Eo1025-03-8x12.pes 11.77x7.48 inches; 91,350 stitches 5 thread changes; 5 colors</p>	 <ul style="list-style-type: none"> ■ 1. Electric Blue (Bro:420) ■ 2. Light Blue (Bro:17) ■ 3. Prussian Blue (Bro:7) ■ 4. Silver (Bro:5) ■ 5. Black (Bro:900) <p>Eo1025-03-8x14.pes 13.75x7.27 inches; 101,816 stitches 5 thread changes; 5 colors</p>
 <ul style="list-style-type: none"> ■ 1. Sky Blue (Bro:19) ■ 2. Ultramarine (Bro:406) ■ 3. Red (Bro:800) ■ 4. Silver (Bro:5) ■ 5. Black (Bro:900) <p>Eo1025-04-4x4.pes 3.89x3.67 inches; 24,575 stitches 5 thread changes; 5 colors</p>	 <ul style="list-style-type: none"> ■ 1. Sky Blue (Bro:19) ■ 2. Ultramarine (Bro:406) ■ 3. Red (Bro:800) ■ 4. Silver (Bro:5) ■ 5. Black (Bro:900) <p>Eo1025-04-5x7.pes 7.02x5.06 inches; 48,396 stitches 5 thread changes; 5 colors</p>	 <ul style="list-style-type: none"> ■ 1. Sky Blue (Bro:19) ■ 2. Ultramarine (Bro:406) ■ 3. Red (Bro:800) ■ 4. Silver (Bro:5) ■ 5. Black (Bro:900) <p>Eo1025-04-6x10.pes 9.78x6.00 inches; 72,628 stitches 5 thread changes; 5 colors</p>	 <ul style="list-style-type: none"> ■ 1. Sky Blue (Bro:19) ■ 2. Ultramarine (Bro:406) ■ 3. Red (Bro:800) ■ 4. Silver (Bro:5) ■ 5. Black (Bro:900) <p>Eo1025-04-8x12.pes 11.29x7.57 inches; 99,120 stitches 5 thread changes; 5 colors</p>	 <ul style="list-style-type: none"> ■ 1. Sky Blue (Bro:19) ■ 2. Ultramarine (Bro:406) ■ 3. Red (Bro:800) ■ 4. Silver (Bro:5) ■ 5. Black (Bro:900) <p>Eo1025-04-8x14.pes 13.65x7.57 inches; 116,228 stitches 5 thread changes; 5 colors</p>

Printed 10/1/2022



- 1. Light Lilac (Bro:810)
- 2. Moss Green (Bro:515)
- 3. Purple (Bro:614)
- 4. Black (Bro:900)

Eo1025-05-4x4.pes
3.93x3.46 inches; 17,614 stitches
4 thread changes; 4 colors



- 1. Light Lilac (Bro:810)
- 2. Moss Green (Bro:515)
- 3. Purple (Bro:614)
- 4. Black (Bro:900)

Eo1025-05-5x7.pes
7.07x4.84 inches; 37,942 stitches
4 thread changes; 4 colors



- 1. Light Lilac (Bro:810)
- 2. Moss Green (Bro:515)
- 3. Purple (Bro:614)
- 4. Black (Bro:900)

Eo1025-05-6x10.pes
9.83x5.97 inches; 61,768 stitches
4 thread changes; 4 colors



- 1. Light Lilac
- 2. Purple
- 3. Moss Green
- 4. Black

Eo1025-05-8x12.pes
11.42x7.37 inches; 81,771 stitches
4 thread changes; 4 colors



- 1. Light Lilac (Bro:810)
- 2. Moss Green (Bro:515)
- 3. Purple (Bro:614)
- 4. Black (Bro:900)

Eo1025-05-8x14.pes
13.56x7.37 inches; 92,836 stitches
4 thread changes; 4 colors



- 1. Dark Gray (Bro:707)
- 2. Silver (Bro:5)
- 3. Black (Bro:900)

Eo1025-06-4x4.pes
3.73x3.78 inches; 14,839 stitches
3 thread changes; 3 colors



- 1. Dark Gray (Bro:707)
- 2. Silver (Bro:5)
- 3. Black (Bro:900)

Eo1025-06-5x7.pes
6.83x4.83 inches; 28,174 stitches
3 thread changes; 3 colors



- 1. Dark Gray (Bro:707)
- 2. Silver (Bro:5)
- 3. Black (Bro:900)

Eo1025-06-6x10.pes
9.69x6.05 inches; 44,809 stitches
3 thread changes; 3 colors



- 1. Dark Gray (Bro:707)
- 2. Silver (Bro:5)
- 3. Black (Bro:900)

Eo1025-06-8x12.pes
11.17x7.50 inches; 60,492 stitches
3 thread changes; 3 colors



- 1. Dark Gray (Bro:707)
- 2. Silver (Bro:5)
- 3. Black (Bro:900)

Eo1025-06-8x14.pes
13.60x7.50 inches; 71,671 stitches
3 thread changes; 3 colors



- 1. Light Brown (Bro:323)
- 2. Leaf Green (Bro:509)
- 3. Silver (Bro:5)
- 4. Black (Bro:900)

Eo1025-07-4x4.pes
3.80x3.75 inches; 27,838 stitches
4 thread changes; 4 colors



- 1. Light Brown (Bro:323)
- 2. Leaf Green (Bro:509)
- 3. Silver (Bro:5)
- 4. Black (Bro:900)

Eo1025-07-5x7.pes
6.82x4.93 inches; 50,502 stitches
4 thread changes; 4 colors



- 1. Light Brown (Bro:323)
- 2. Leaf Green (Bro:509)
- 3. Silver (Bro:5)
- 4. Black (Bro:900)

Eo1025-07-6x10.pes
10.04x5.98 inches; 78,697 stitches
4 thread changes; 4 colors

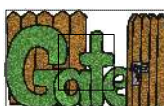

- 1. Light Brown (Bro:323)
- 2. Leaf Green (Bro:509)
- 3. Silver (Bro:5)
- 4. Black (Bro:900)

Eo1025-07-8x12.pes
11.33x7.35 inches; 103,249 stitches
4 thread changes; 4 colors



- 1. Light Brown (Bro:323)
- 2. Leaf Green (Bro:509)
- 3. Silver (Bro:5)
- 4. Black (Bro:900)

Eo1025-07-8x14.pes
13.69x7.35 inches; 119,222 stitches
4 thread changes; 4 colors



- 1. Harvest Gold (Bro:206)
- 2. Light Blue (Bro:17)
- 3. Red (Bro:800)
- 4. Light Brown (Bro:323)
- 5. Dark Gray (Bro:707)
- 6. Black (Bro:900)

Eo1025-08-4x4.pes
3.87x3.78 inches; 21,323 stitches
6 thread changes; 6 colors



- 1. Harvest Gold (Bro:206)
- 2. Light Blue (Bro:17)
- 3. Red (Bro:800)
- 4. Light Brown (Bro:323)
- 5. Dark Gray (Bro:707)
- 6. Black (Bro:900)

Eo1025-08-5x7.pes
6.75x4.91 inches; 37,660 stitches
6 thread changes; 6 colors



- 1. Harvest Gold (Bro:206)
- 2. Light Blue (Bro:17)
- 3. Red (Bro:800)
- 4. Light Brown (Bro:323)
- 5. Dark Gray (Bro:707)
- 6. Black (Bro:900)

Eo1025-08-6x10.pes
9.83x6.07 inches; 58,791 stitches
6 thread changes; 6 colors



- 1. Harvest Gold (Bro:206)
- 2. Light Blue (Bro:17)
- 3. Red (Bro:800)
- 4. Light Brown (Bro:323)
- 5. Dark Gray (Bro:707)
- 6. Black (Bro:900)

Eo1025-08-8x12.pes
11.50x7.56 inches; 79,500 stitches
6 thread changes; 6 colors



- 1. Harvest Gold (Bro:206)
- 2. Light Blue (Bro:17)
- 3. Red (Bro:800)
- 4. Light Brown (Bro:323)
- 5. Dark Gray (Bro:707)
- 6. Black (Bro:900)

Eo1025-08-8x14.pes
13.81x7.56 inches; 92,374 stitches
6 thread changes; 6 colors

 <ul style="list-style-type: none"> ■ 1. Light Blue (Bro:17) ■ 2. Black (Bro:900) <p>Eo1025-09-4x4.pes 3.76x3.80 inches; 21,235 stitches 2 thread changes; 2 colors</p>	 <ul style="list-style-type: none"> ■ 1. Light Blue (Bro:17) ■ 2. Black (Bro:900) <p>Eo1025-09-5x7.pes 6.66x4.93 inches; 40,506 stitches 2 thread changes; 2 colors</p>	 <ul style="list-style-type: none"> ■ 1. Light Blue (Bro:17) ■ 2. Black (Bro:900) <p>Eo1025-09-6x10.pes 9.79x5.94 inches; 65,107 stitches 2 thread changes; 2 colors</p>	 <ul style="list-style-type: none"> ■ 1. Light Blue (Bro:17) ■ 2. Black (Bro:900) <p>Eo1025-09-8x12.pes 11.37x7.49 inches; 89,308 stitches 2 thread changes; 2 colors</p>	 <ul style="list-style-type: none"> ■ 1. Light Blue (Bro:17) ■ 2. Black (Bro:900) <p>Eo1025-09-8x14.pes 13.73x7.50 inches; 106,023 stitches 2 thread changes; 2 colors</p>
 <ul style="list-style-type: none"> ■ 1. Silver (Bro:5) ■ 2. Light Blue (Bro:17) ■ 3. Dark Fuchsia (Bro:107) ■ 4. Black (Bro:900) <p>Eo1025-10-4x4.pes 3.85x3.80 inches; 20,477 stitches 4 thread changes; 4 colors</p>	 <ul style="list-style-type: none"> ■ 1. Silver (Bro:5) ■ 2. Light Blue (Bro:17) ■ 3. Dark Fuchsia (Bro:107) ■ 4. Black (Bro:900) <p>Eo1025-10-5x7.pes 6.78x4.85 inches; 36,855 stitches 4 thread changes; 4 colors</p>	 <ul style="list-style-type: none"> ■ 1. Silver (Bro:5) ■ 2. Light Blue (Bro:17) ■ 3. Dark Fuchsia (Bro:107) ■ 4. Black (Bro:900) <p>Eo1025-10-6x10.pes 9.90x6.06 inches; 59,263 stitches 4 thread changes; 4 colors</p>	 <ul style="list-style-type: none"> ■ 1. Silver (Bro:5) ■ 2. Light Blue (Bro:17) ■ 3. Dark Fuchsia (Bro:107) ■ 4. Black (Bro:900) <p>Eo1025-10-8x12.pes 11.46x7.47 inches; 79,515 stitches 4 thread changes; 4 colors</p>	 <ul style="list-style-type: none"> ■ 1. Silver (Bro:5) ■ 2. Light Blue (Bro:17) ■ 3. Dark Fuchsia (Bro:107) ■ 4. Black (Bro:900) <p>Eo1025-10-8x14.pes 13.80x7.47 inches; 93,312 stitches 4 thread changes; 4 colors</p>
 <ul style="list-style-type: none"> ■ 1. Electric Blue (Bro:420) ■ 2. Purple (Bro:614) ■ 3. Violet (Bro:613) ■ 4. Lilac (Bro:612) ■ 5. Light Lilac (Bro:810) ■ 6. Black (Bro:900) <p>Eo1025-11-4x4.pes 3.84x3.86 inches; 22,698 stitches 6 thread changes; 6 colors</p>	 <ul style="list-style-type: none"> ■ 1. Electric Blue (Bro:420) ■ 2. Purple (Bro:614) ■ 3. Violet (Bro:613) ■ 4. Lilac (Bro:612) ■ 5. Light Lilac (Bro:810) ■ 6. Black (Bro:900) <p>Eo1025-11-5x7.pes 6.89x4.87 inches; 38,796 stitches 6 thread changes; 6 colors</p>	 <ul style="list-style-type: none"> ■ 1. Electric Blue (Bro:420) ■ 2. Purple (Bro:614) ■ 3. Violet (Bro:613) ■ 4. Lilac (Bro:612) ■ 5. Light Lilac (Bro:810) ■ 6. Black (Bro:900) <p>Eo1025-11-6x10.pes 9.84x6.03 inches; 58,245 stitches 6 thread changes; 6 colors</p>	 <ul style="list-style-type: none"> ■ 1. Electric Blue (Bro:420) ■ 2. Purple (Bro:614) ■ 3. Violet (Bro:613) ■ 4. Lilac (Bro:612) ■ 5. Light Lilac (Bro:810) ■ 6. Black (Bro:900) <p>Eo1025-11-8x12.pes 11.45x7.42 inches; 76,539 stitches 6 thread changes; 6 colors</p>	 <ul style="list-style-type: none"> ■ 1. Electric Blue (Bro:420) ■ 2. Purple (Bro:614) ■ 3. Violet (Bro:613) ■ 4. Lilac (Bro:612) ■ 5. Light Lilac (Bro:810) ■ 6. Black (Bro:900) <p>Eo1025-11-8x14.pes 13.65x7.85 inches; 89,795 stitches 6 thread changes; 6 colors</p>
 <ul style="list-style-type: none"> ■ 1. Harvest Gold (Bro:206) ■ 2. Light Lilac (Bro:810) ■ 3. Electric Blue (Bro:420) ■ 4. Black (Bro:900) <p>Eo1025-12-4x4.pes 3.93x3.58 inches; 14,331 stitches 4 thread changes; 4 colors</p>	 <ul style="list-style-type: none"> ■ 1. Harvest Gold (Bro:206) ■ 2. Light Lilac (Bro:810) ■ 3. Electric Blue (Bro:420) ■ 4. Black (Bro:900) <p>Eo1025-12-5x7.pes 6.89x4.89 inches; 31,919 stitches 4 thread changes; 4 colors</p>	 <ul style="list-style-type: none"> ■ 1. Harvest Gold (Bro:206) ■ 2. Light Lilac (Bro:810) ■ 3. Electric Blue (Bro:420) ■ 4. Black (Bro:900) <p>Eo1025-12-6x10.pes 9.79x6.04 inches; 49,547 stitches 4 thread changes; 4 colors</p>	 <ul style="list-style-type: none"> ■ 1. Harvest Gold (Bro:206) ■ 2. Light Lilac (Bro:810) ■ 3. Electric Blue (Bro:420) ■ 4. Black (Bro:900) <p>Eo1025-12-8x12.pes 11.47x7.06 inches; 63,908 stitches 4 thread changes; 4 colors</p>	 <ul style="list-style-type: none"> ■ 1. Harvest Gold (Bro:206) ■ 2. Light Lilac (Bro:810) ■ 3. Electric Blue (Bro:420) ■ 4. Black (Bro:900) <p>Eo1025-12-8x14.pes 13.57x7.06 inches; 73,034 stitches 4 thread changes; 4 colors</p>



- 1. Black (Bro:900)
- 2. Light Brown (Bro:323)
- 3. Deep Gold (Bro:214)
- 4. Harvest Gold (Bro:206)
- 5. Cream Brown (Bro:10)
- 6. Black (Bro:900)

Eo1025-13-4x4.pes
3.91x3.81 inches; 15,003 stitches
6 thread changes; 5 colors



- 1. Black (Bro:900)
- 2. Light Brown (Bro:323)
- 3. Deep Gold (Bro:214)
- 4. Harvest Gold (Bro:206)
- 5. Cream Brown (Bro:10)
- 6. Black (Bro:900)

Eo1025-13-5x7.pes
6.83x4.91 inches; 28,243 stitches
6 thread changes; 5 colors



- 1. Black (Bro:900)
- 2. Light Brown (Bro:323)
- 3. Deep Gold (Bro:214)
- 4. Harvest Gold (Bro:206)
- 5. Cream Brown (Bro:10)
- 6. Black (Bro:900)

Eo1025-13-6x10.pes
9.91x5.82 inches; 45,108 stitches
6 thread changes; 5 colors



- 1. Black (Bro:900)
- 2. Light Brown (Bro:323)
- 3. Deep Gold (Bro:214)
- 4. Harvest Gold (Bro:206)
- 5. Cream Brown (Bro:10)
- 6. Black (Bro:900)

Eo1025-13-8x12.pes
11.21x7.43 inches; 62,383 stitches
6 thread changes; 5 colors



- 1. Black (Bro:900)
- 2. Light Brown (Bro:323)
- 3. Deep Gold (Bro:214)
- 4. Harvest Gold (Bro:206)
- 5. Cream Brown (Bro:10)
- 6. Black (Bro:900)

Eo1025-13-8x14.pes
13.83x7.43 inches; 76,494 stitches
6 thread changes; 5 colors

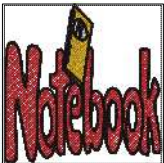

- 1. White (Bro:1)
- 2. Red (Bro:800)
- 3. Deep Gold (Bro:214)
- 4. Black (Bro:900)

Eo1025-14-4x4.pes
3.84x3.87 inches; 22,301 stitches
4 thread changes; 4 colors



- 1. White (Bro:1)
- 2. Red (Bro:800)
- 3. Deep Gold (Bro:214)
- 4. Black (Bro:900)

Eo1025-14-5x7.pes
6.78x4.91 inches; 36,830 stitches
4 thread changes; 4 colors



- 1. White (Bro:1)
- 2. Red (Bro:800)
- 3. Deep Gold (Bro:214)
- 4. Black (Bro:900)

Eo1025-14-6x10.pes
10.02x5.91 inches; 55,207 stitches
4 thread changes; 4 colors

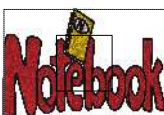

- 1. White (Bro:1)
- 2. Red (Bro:800)
- 3. Deep Gold (Bro:214)
- 4. Black (Bro:900)

Eo1025-14-8x12.pes
11.30x7.55 inches; 74,675 stitches
4 thread changes; 4 colors



- 1. White (Bro:1)
- 2. Red (Bro:800)
- 3. Deep Gold (Bro:214)
- 4. Black (Bro:900)

Eo1025-14-8x14.pes
13.74x7.55 inches; 86,052 stitches
4 thread changes; 4 colors



- 1. Vermilion (Bro:30)
- 2. Orange (Bro:208)
- 3. Leaf Green (Bro:509)
- 4. Black (Bro:900)

Eo1025-15-4x4.pes
3.89x3.68 inches; 21,868 stitches
4 thread changes; 4 colors



- 1. Vermilion (Bro:30)
- 2. Orange (Bro:208)
- 3. Leaf Green (Bro:509)
- 4. Black (Bro:900)

Eo1025-15-5x7.pes
6.79x4.92 inches; 38,340 stitches
4 thread changes; 4 colors



- 1. Vermilion (Bro:30)
- 2. Orange (Bro:208)
- 3. Leaf Green (Bro:509)
- 4. Black (Bro:900)

Eo1025-15-6x10.pes
9.81x6.00 inches; 56,709 stitches
4 thread changes; 4 colors



- 1. Vermilion (Bro:30)
- 2. Orange (Bro:208)
- 3. Leaf Green (Bro:509)
- 4. Black (Bro:900)

Eo1025-15-8x12.pes
11.42x7.46 inches; 72,632 stitches
4 thread changes; 4 colors



- 1. Vermilion (Bro:30)
- 2. Orange (Bro:208)
- 3. Leaf Green (Bro:509)
- 4. Black (Bro:900)

Eo1025-15-8x14.pes
14.14x7.59 inches; 95,501 stitches
4 thread changes; 4 colors

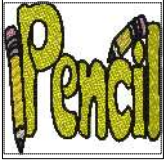

- 1. Pink (Bro:85)
- 2. Yellow (Bro:205)
- 3. Harvest Gold (Bro:206)
- 4. Beige (Bro:843)
- 5. Silver (Bro:5)
- 6. Dark Gray (Bro:707)
- 7. Black (Bro:900)

Eo1025-16-4x4.pes
3.85x3.70 inches; 21,868 stitches
7 thread changes; 7 colors

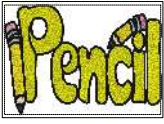

- 1. Pink (Bro:85)
- 2. Yellow (Bro:205)
- 3. Harvest Gold (Bro:206)
- 4. Beige (Bro:843)
- 5. Silver (Bro:5)
- 6. Dark Gray (Bro:707)
- 7. Black (Bro:900)

Eo1025-16-5x7.pes
6.89x4.82 inches; 38,917 stitches
7 thread changes; 7 colors



- 1. Pink (Bro:85)
- 2. Yellow (Bro:205)
- 3. Harvest Gold (Bro:206)
- 4. Beige (Bro:843)
- 5. Silver (Bro:5)
- 6. Dark Gray (Bro:707)
- 7. Black (Bro:900)

Eo1025-16-6x10.pes
10.04x5.97 inches; 61,180 stitches
7 thread changes; 7 colors



- 1. Pink (Bro:85)
- 2. Yellow (Bro:205)
- 3. Harvest Gold (Bro:206)
- 4. Beige (Bro:843)
- 5. Silver (Bro:5)
- 6. Dark Gray (Bro:707)
- 7. Black (Bro:900)

Eo1025-16-8x12.pes
11.44x7.41 inches; 81,700 stitches
7 thread changes; 7 colors

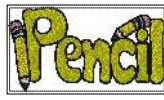

- 1. Pink (Bro:85)
- 2. Yellow (Bro:205)
- 3. Harvest Gold (Bro:206)
- 4. Beige (Bro:843)
- 5. Silver (Bro:5)
- 6. Dark Gray (Bro:707)
- 7. Black (Bro:900)

Eo1025-16-8x14.pes
13.70x7.41 inches; 93,960 stitches
7 thread changes; 7 colors

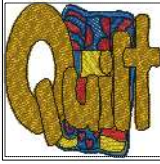

- 1. Red (Bro:800)
- 2. Electric Blue (Bro:420)
- 3. Harvest Gold (Bro:206)
- 4. Deep Gold (Bro:214)
- 5. Black (Bro:900)

Eo1025-17-4x4.pes
3.81x3.76 inches; 25,012 stitches
5 thread changes; 5 colors



- 1. Red (Bro:800)
- 2. Electric Blue (Bro:420)
- 3. Harvest Gold (Bro:206)
- 4. Deep Gold (Bro:214)
- 5. Black (Bro:900)

Eo1025-17-5x7.pes
6.81x4.85 inches; 47,125 stitches
5 thread changes; 5 colors



- 1. Red (Bro:800)
- 2. Electric Blue (Bro:420)
- 3. Harvest Gold (Bro:206)
- 4. Deep Gold (Bro:214)
- 5. Black (Bro:900)

Eo1025-17-6x10.pes
9.90x6.04 inches; 76,885 stitches
5 thread changes; 5 colors

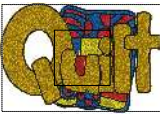

- 1. Red (Bro:800)
- 2. Electric Blue (Bro:420)
- 3. Harvest Gold (Bro:206)
- 4. Deep Gold (Bro:214)
- 5. Black (Bro:900)

Eo1025-17-8x12.pes
11.39x7.56 inches; 105,157 stitches
5 thread changes; 5 colors



- 1. Red (Bro:800)
- 2. Electric Blue (Bro:420)
- 3. Harvest Gold (Bro:206)
- 4. Deep Gold (Bro:214)
- 5. Black (Bro:900)

Eo1025-17-8x14.pes
13.68x7.59 inches; 138,711 stitches
5 thread changes; 5 colors

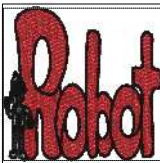

- 1. Red (Bro:800)
- 2. Silver (Bro:5)
- 3. Gray (Bro:817)
- 4. Dark Gray (Bro:707)
- 5. Black (Bro:900)

Eo1025-18-4x4.pes
3.88x3.73 inches; 20,577 stitches
5 thread changes; 5 colors



- 1. Red (Bro:800)
- 2. Silver (Bro:5)
- 3. Gray (Bro:817)
- 4. Dark Gray (Bro:707)
- 5. Black (Bro:900)

Eo1025-18-5x7.pes
6.80x4.92 inches; 45,913 stitches
5 thread changes; 5 colors



- 1. Red (Bro:800)
- 2. Silver (Bro:5)
- 3. Gray (Bro:817)
- 4. Dark Gray (Bro:707)
- 5. Black (Bro:900)

Eo1025-18-6x10.pes
9.96x5.98 inches; 71,108 stitches
5 thread changes; 5 colors



- 1. Red (Bro:800)
- 2. Silver (Bro:5)
- 3. Gray (Bro:817)
- 4. Dark Gray (Bro:707)
- 5. Black (Bro:900)

Eo1025-18-8x12.pes
11.77x7.83 inches; 103,258 stitches
5 thread changes; 5 colors



- 1. Red (Bro:800)
- 2. Silver (Bro:5)
- 3. Gray (Bro:817)
- 4. Dark Gray (Bro:707)
- 5. Black (Bro:900)

Eo1025-18-8x14.pes
13.74x7.62 inches; 113,674 stitches
5 thread changes; 5 colors



- 1. Red (Bro:800)
- 2. Electric Blue (Bro:420)
- 3. Silver (Bro:5)
- 4. Black (Bro:900)

Eo1025-19-4x4.pes
3.87x3.72 inches; 14,955 stitches
4 thread changes; 4 colors



- 1. Red (Bro:800)
- 2. Electric Blue (Bro:420)
- 3. Silver (Bro:5)
- 4. Black (Bro:900)

Eo1025-19-5x7.pes
6.67x4.85 inches; 34,176 stitches
4 thread changes; 4 colors



- 1. Red (Bro:800)
- 2. Electric Blue (Bro:420)
- 3. Silver (Bro:5)
- 4. Black (Bro:900)

Eo1025-19-6x10.pes
9.72x5.98 inches; 54,555 stitches
4 thread changes; 4 colors



- 1. Red (Bro:800)
- 2. Electric Blue (Bro:420)
- 3. Silver (Bro:5)
- 4. Black (Bro:900)

Eo1025-19-8x12.pes
11.38x7.38 inches; 74,765 stitches
4 thread changes; 4 colors



- 1. Red (Bro:800)
- 2. Electric Blue (Bro:420)
- 3. Silver (Bro:5)
- 4. Black (Bro:900)

Eo1025-19-8x14.pes
13.55x7.38 inches; 86,488 stitches
4 thread changes; 4 colors



- 1. Light Brown (Bro:323)
- 2. Leaf Green (Bro:509)
- 3. Moss Green (Bro:515)
- 4. Black (Bro:900)

Eo1025-20-4x4.pes
3.82x3.91 inches; 22,883 stitches
4 thread changes; 4 colors



- 1. Light Brown (Bro:323)
- 2. Leaf Green (Bro:509)
- 3. Moss Green (Bro:515)
- 4. Black (Bro:900)

Eo1025-20-5x7.pes
6.74x4.87 inches; 40,175 stitches
4 thread changes; 4 colors



- 1. Light Brown (Bro:323)
- 2. Leaf Green (Bro:509)
- 3. Moss Green (Bro:515)
- 4. Black (Bro:900)

Eo1025-20-6x10.pes
9.79x6.10 inches; 63,980 stitches
4 thread changes; 4 colors



- 1. Light Brown (Bro:323)
- 2. Leaf Green (Bro:509)
- 3. Moss Green (Bro:515)
- 4. Black (Bro:900)

Eo1025-20-8x12.pes
11.42x7.30 inches; 83,449 stitches
4 thread changes; 4 colors



- 1. Light Brown (Bro:323)
- 2. Leaf Green (Bro:509)
- 3. Moss Green (Bro:515)
- 4. Black (Bro:900)

Eo1025-20-8x14.pes
13.62x7.30 inches; 96,897 stitches
4 thread changes; 4 colors



- 1. Red (Bro:800)
- 2. Gray (Bro:817)
- 3. Deep Gold (Bro:214)
- 4. Electric Blue (Bro:420)
- 5. Harvest Gold (Bro:206)
- 6. Black (Bro:900)

Eo1025-21-4x4.pes
3.77x3.66 inches; 18,840 stitches
6 thread changes; 6 colors



- 1. Red (Bro:800)
- 2. Gray (Bro:817)
- 3. Deep Gold (Bro:214)
- 4. Electric Blue (Bro:420)
- 5. Harvest Gold (Bro:206)
- 6. Black (Bro:900)

Eo1025-21-5x7.pes
6.96x4.87 inches; 30,553 stitches
6 thread changes; 6 colors



- 1. Red (Bro:800)
- 2. Gray (Bro:817)
- 3. Deep Gold (Bro:214)
- 4. Electric Blue (Bro:420)
- 5. Harvest Gold (Bro:206)
- 6. Black (Bro:900)

Eo1025-21-6x10.pes
9.82x5.99 inches; 49,989 stitches
6 thread changes; 6 colors



- 1. Red (Bro:800)
- 2. Gray (Bro:817)
- 3. Deep Gold (Bro:214)
- 4. Electric Blue (Bro:420)
- 5. Harvest Gold (Bro:206)
- 6. Black (Bro:900)

Eo1025-21-8x12.pes
11.39x7.21 inches; 65,224 stitches
6 thread changes; 6 colors



- 1. Red (Bro:800)
- 2. Gray (Bro:817)
- 3. Deep Gold (Bro:214)
- 4. Electric Blue (Bro:420)
- 5. Harvest Gold (Bro:206)
- 6. Black (Bro:900)

Eo1025-21-8x14.pes
13.67x7.42 inches; 76,556 stitches
6 thread changes; 6 colors



- 1. Teal Green (Bro:534)
- 2. Pink (Bro:85)
- 3. Dark Fuchsia (Bro:107)
- 4. Beige (Bro:843)
- 5. Black (Bro:900)

Eo1025-22-4x4.pes
3.76x3.67 inches; 21,193 stitches
5 thread changes; 5 colors



- 1. Teal Green (Bro:534)
- 2. Pink (Bro:85)
- 3. Dark Fuchsia (Bro:107)
- 4. Beige (Bro:843)
- 5. Black (Bro:900)

Eo1025-22-5x7.pes
6.78x4.91 inches; 38,282 stitches
5 thread changes; 5 colors



- 1. Teal Green (Bro:534)
- 2. Pink (Bro:85)
- 3. Dark Fuchsia (Bro:107)
- 4. Beige (Bro:843)
- 5. Black (Bro:900)

Eo1025-22-6x10.pes
9.91x6.05 inches; 59,567 stitches
5 thread changes; 5 colors



- 1. Teal Green (Bro:534)
- 2. Pink (Bro:85)
- 3. Dark Fuchsia (Bro:107)
- 4. Beige (Bro:843)
- 5. Black (Bro:900)

Eo1025-22-8x12.pes
11.44x7.52 inches; 79,262 stitches
5 thread changes; 5 colors



- 1. Teal Green (Bro:534)
- 2. Pink (Bro:85)
- 3. Dark Fuchsia (Bro:107)
- 4. Beige (Bro:843)
- 5. Black (Bro:900)

Eo1025-22-8x14.pes
13.73x7.52 inches; 92,019 stitches
5 thread changes; 5 colors



- 1. Light Blue (Bro:17)
- 2. Light Brown (Bro:323)
- 3. Blue (Bro:405)
- 4. Black (Bro:900)

Eo1025-23-4x4.pes
3.82x3.75 inches; 20,270 stitches
4 thread changes; 4 colors



- 1. Light Blue (Bro:17)
- 2. Light Brown (Bro:323)
- 3. Blue (Bro:405)
- 4. Black (Bro:900)

Eo1025-23-5x7.pes
6.86x4.92 inches; 43,607 stitches
4 thread changes; 4 colors



- 1. Light Blue (Bro:17)
- 2. Light Brown (Bro:323)
- 3. Blue (Bro:405)
- 4. Black (Bro:900)

Eo1025-23-6x10.pes
9.86x6.01 inches; 64,838 stitches
4 thread changes; 4 colors



- 1. Light Blue (Bro:17)
- 2. Light Brown (Bro:323)
- 3. Blue (Bro:405)
- 4. Black (Bro:900)

Eo1025-23-8x12.pes
11.47x7.51 inches; 87,223 stitches
4 thread changes; 4 colors



- 1. Light Blue (Bro:17)
- 2. Light Brown (Bro:323)
- 3. Blue (Bro:405)
- 4. Black (Bro:900)

Eo1025-23-8x14.pes
13.67x7.51 inches; 98,981 stitches
4 thread changes; 4 colors



- 1. Deep Gold (Bro:214)
- 2. Beige (Bro:843)
- 3. Electric Blue (Bro:420)
- 4. Pink (Bro:85)
- 5. Black (Bro:900)

Eo1025-24-4x4.pes
3.91x3.80 inches; 27,310 stitches
5 thread changes; 5 colors



- 1. Deep Gold (Bro:214)
- 2. Beige (Bro:843)
- 3. Electric Blue (Bro:420)
- 4. Pink (Bro:85)
- 5. Black (Bro:900)

Eo1025-24-5x7.pes
6.81x4.94 inches; 43,073 stitches
5 thread changes; 5 colors



- 1. Deep Gold (Bro:214)
- 2. Beige (Bro:843)
- 3. Electric Blue (Bro:420)
- 4. Pink (Bro:85)
- 5. Black (Bro:900)

Eo1025-24-6x10.pes
9.97x6.09 inches; 63,654 stitches
5 thread changes; 5 colors



- 1. Deep Gold (Bro:214)
- 2. Beige (Bro:843)
- 3. Electric Blue (Bro:420)
- 4. Pink (Bro:85)
- 5. Black (Bro:900)

Eo1025-24-8x12.pes
11.40x7.53 inches; 83,128 stitches
5 thread changes; 5 colors



- 1. Deep Gold (Bro:214)
- 2. Beige (Bro:843)
- 3. Electric Blue (Bro:420)
- 4. Pink (Bro:85)
- 5. Black (Bro:900)

Eo1025-24-8x14.pes
13.79x7.53 inches; 94,039 stitches
5 thread changes; 5 colors

Printed 10/1/2022



- 1. Dark Fuchsia (Bro:107)
- 2. Deep Gold (Bro:214)
- 3. Silver (Bro:5)
- 4. Black (Bro:900)

Eo1025-25-4x4.pes
3.81x3.70 inches; 15,803 stitches
4 thread changes; 4 colors



- 1. Dark Fuchsia (Bro:107)
- 2. Deep Gold (Bro:214)
- 3. Silver (Bro:5)
- 4. Black (Bro:900)

Eo1025-25-5x7.pes
6.93x5.00 inches; 28,779 stitches
4 thread changes; 4 colors



- 1. Dark Fuchsia (Bro:107)
- 2. Deep Gold (Bro:214)
- 3. Silver (Bro:5)
- 4. Black (Bro:900)

Eo1025-25-6x10.pes
9.97x6.06 inches; 43,121 stitches
4 thread changes; 4 colors



- 1. Dark Fuchsia (Bro:107)
- 2. Deep Gold (Bro:214)
- 3. Silver (Bro:5)
- 4. Black (Bro:900)

Eo1025-25-8x12.pes
11.75x7.70 inches; 58,929 stitches
4 thread changes; 4 colors



- 1. Dark Fuchsia (Bro:107)
- 2. Deep Gold (Bro:214)
- 3. Silver (Bro:5)
- 4. Black (Bro:900)

Eo1025-25-8x14.pes
13.61x7.49 inches; 64,933 stitches
4 thread changes; 4 colors



- 1. Electric Blue (Bro:420)
- 2. Silver (Bro:5)
- 3. Black (Bro:900)

Eo1025-26-4x4.pes
3.90x3.59 inches; 12,923 stitches
3 thread changes; 3 colors



- 1. Electric Blue (Bro:420)
- 2. Silver (Bro:5)
- 3. Black (Bro:900)

Eo1025-26-5x7.pes
6.64x4.97 inches; 30,155 stitches
3 thread changes; 3 colors



- 1. Electric Blue (Bro:420)
- 2. Silver (Bro:5)
- 3. Black (Bro:900)

Eo1025-26-6x10.pes
6.81x4.79 inches; 26,843 stitches
3 thread changes; 3 colors



- 1. Electric Blue (Bro:420)
- 2. Silver (Bro:5)
- 3. Black (Bro:900)

Eo1025-26-8x12.pes
11.48x7.49 inches; 61,472 stitches
3 thread changes; 3 colors



- 1. Electric Blue (Bro:420)
- 2. Silver (Bro:5)
- 3. Black (Bro:900)

Eo1025-26-8x14.pes
13.69x7.49 inches; 69,560 stitches
3 thread changes; 3 colors



- 1. Electric Blue (Bro:420)
- 2. White (Bro:1)
- 3. Red (Bro:800)
- 4. Prussian Blue (Bro:7)
- 5. Black (Bro:900)

Eo1025-27-4x4.pes
3.84x3.81 inches; 20,280 stitches
5 thread changes; 5 colors



- 1. Electric Blue (Bro:420)
- 2. White (Bro:1)
- 3. Red (Bro:800)
- 4. Prussian Blue (Bro:7)
- 5. Black (Bro:900)

Eo1025-27-5x7.pes
6.74x4.93 inches; 35,761 stitches
5 thread changes; 5 colors



- 1. Electric Blue (Bro:420)
- 2. White (Bro:1)
- 3. Red (Bro:800)
- 4. Prussian Blue (Bro:7)
- 5. Black (Bro:900)

Eo1025-27-6x10.pes
9.80x6.04 inches; 55,885 stitches
5 thread changes; 5 colors



- 1. Electric Blue (Bro:420)
- 2. White (Bro:1)
- 3. Red (Bro:800)
- 4. Prussian Blue (Bro:7)
- 5. Black (Bro:900)

Eo1025-27-8x12.pes
11.40x7.54 inches; 75,569 stitches
5 thread changes; 5 colors



- 1. Electric Blue (Bro:420)
- 2. White (Bro:1)
- 3. Red (Bro:800)
- 4. Prussian Blue (Bro:7)
- 5. Black (Bro:900)

Eo1025-27-8x14.pes
13.58x7.54 inches; 86,913 stitches
5 thread changes; 5 colors