

Please enjoy this fun set of Easter patterns. They sew out quickly in Bean stitch, I would love a photo of your finished work. They would be pretty in soft pastel variegated threads.

D:\00 SEWING AND EMBROIDERY\00 EMERALD ORIGINALS\000 non golden group sets\00000 EO Sets\EO836-EO837-EASTER BLESSINGS\EO837-BW\EO837-WORKING\EO837-all sizes

Printed 2/10/2020

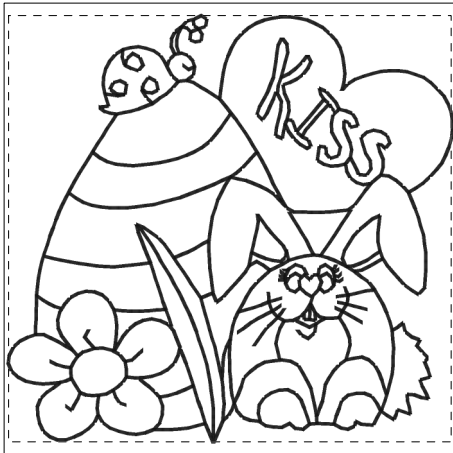

■ 1. Black

Eo837-Bw-01-4x4.pes

3.85x3.71 inches; 4,122 stitches
1 thread changes; 1 colors

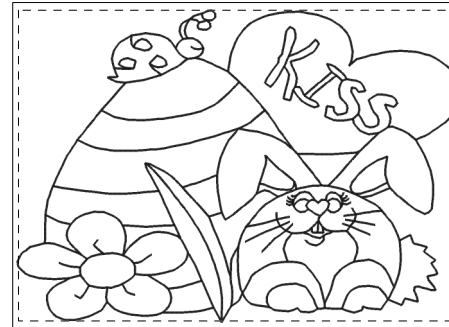

■ 1. Black

Eo837-Bw-01-5x7.pes

6.91x4.87 inches; 6,072 stitches
1 thread changes; 1 colors

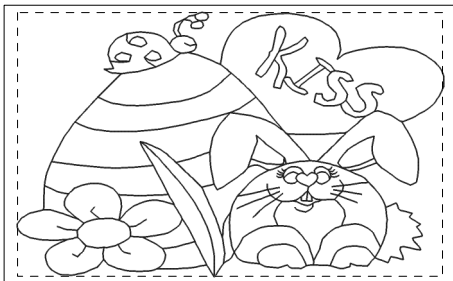

■ 1. Black

Eo837-Bw-01-6x10.pes

9.63x5.97 inches; 7,830 stitches
1 thread changes; 1 colors

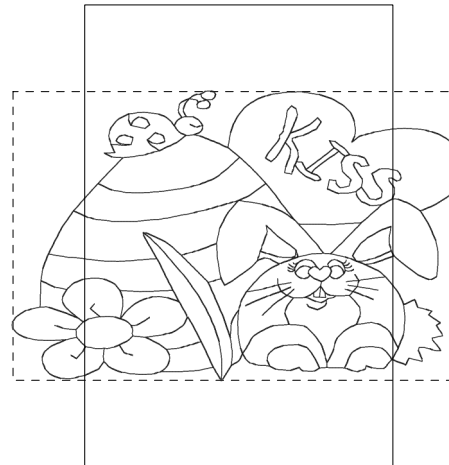

■ 1. Black (Bro:900)

Eo837-Bw-01-8x12.pes

11.53x7.38 inches; 9,459 stitches
1 thread changes; 1 colors

Please enjoy this fun set of Easter patterns. They sew out quickly in Bean stitch, I would love a photo of your finished work. They would be pretty in soft pastel variagated threads.

D:\00 SEWING AND EMBROIDERY\00 EMERALD ORIGINALS\000 non golden group sets\00000 EO Sets\EO836-EO837-EASTER BLESSINGS\EO837-BW\EO837-WORKING\EO837-all sizes

Printed 2/10/2020

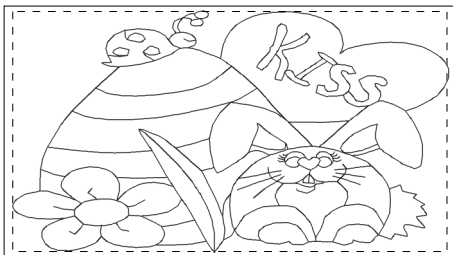

■ 1. Black (Bro:900)

Eo837-Bw-01-8x14.pes
13.62x7.54 inches; 10,522 stitches
1 thread changes; 1 colors

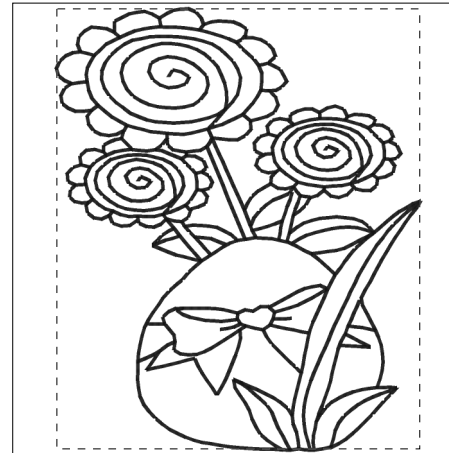

■ 1. Black

Eo837-Bw-02-4x4.pes
3.16x3.83 inches; 4,258 stitches
1 thread changes; 1 colors



■ 1. Black

Eo837-Bw-02-5x7.pes
4.92x6.83 inches; 6,738 stitches
1 thread changes; 1 colors

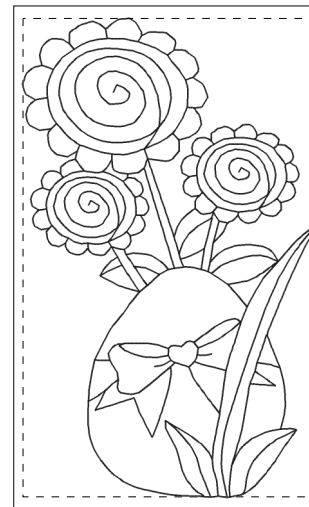

■ 1. Black

Eo837-Bw-02-6x10.pes
5.92x9.73 inches; 8,662 stitches
1 thread changes; 1 colors

Please enjoy this fun set of Easter patterns. They sew out quickly in Bean stitch, I would love a photo of your finished work. They would be pretty in soft pastel variagated threads.

D:\00 SEWING AND EMBROIDERY\00 EMERALD ORIGINALS\000 non golden group sets\00000 EO Sets\EO836-EO837-EASTER BLESSINGS\EO837-BW\EO837-WORKING\EO837-all sizes

Printed 2/10/2020

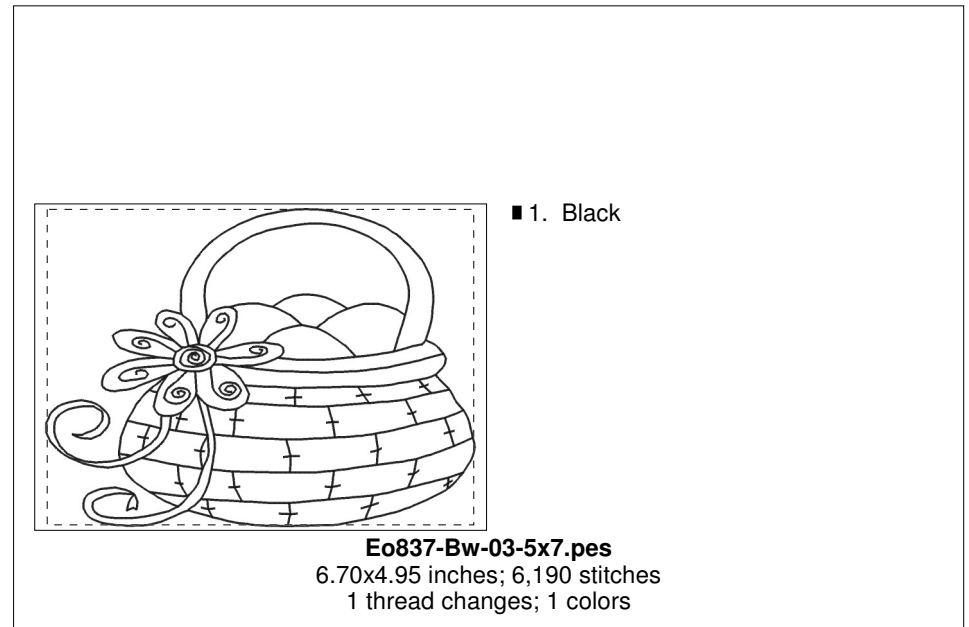
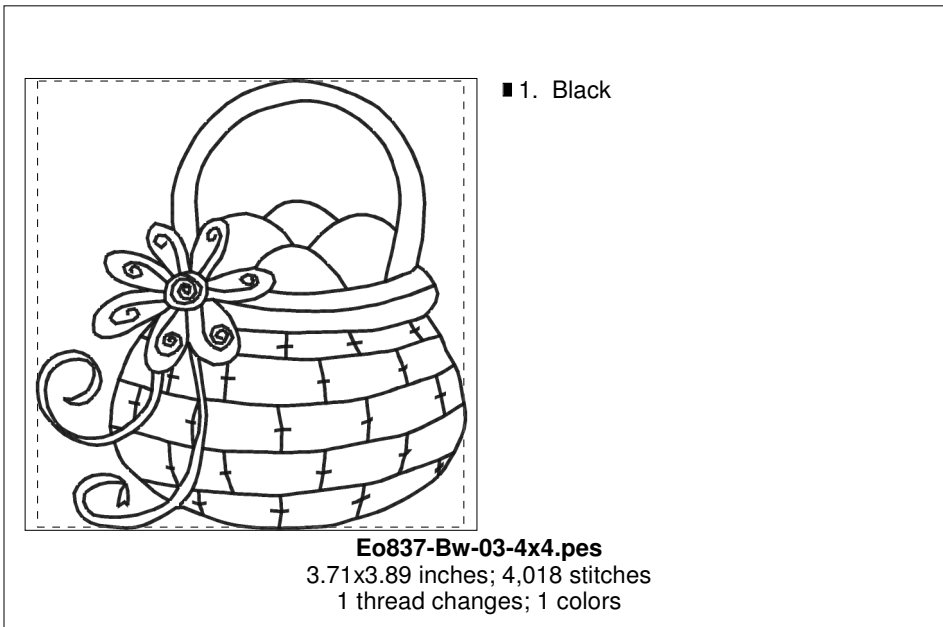
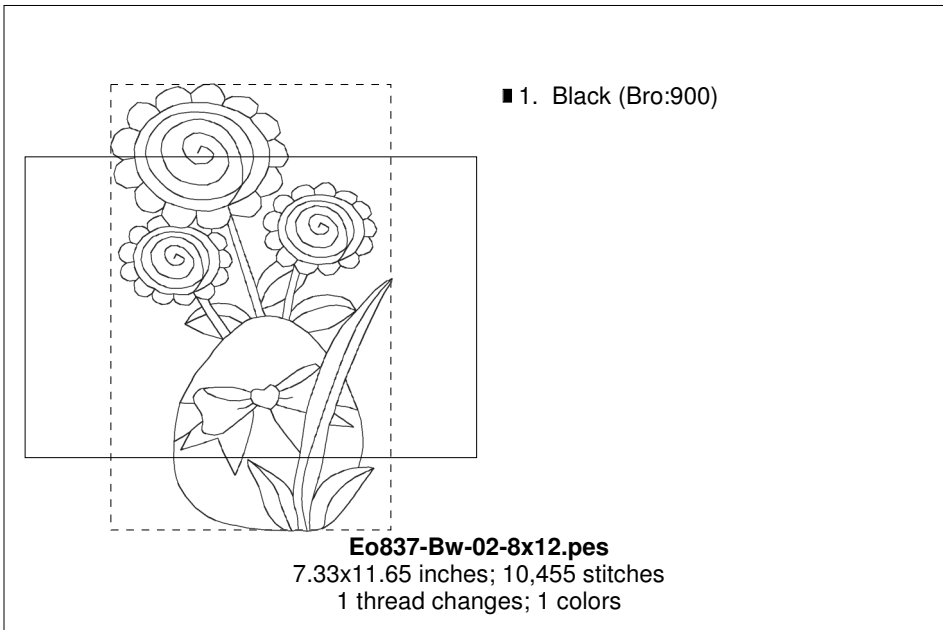

Please enjoy this fun set of Easter patterns. They sew out quickly in Bean stitch, I would love a photo of your finished work. They would be pretty in soft pastel variagated threads.

D:\00 SEWING AND EMBROIDERY\00 EMERALD ORIGINALS\000 non golden group sets\00000 EO Sets\EO836-EO837-EASTER BLESSINGS\EO837-BW\EO837-WORKING\EO837-all sizes

Printed 2/10/2020

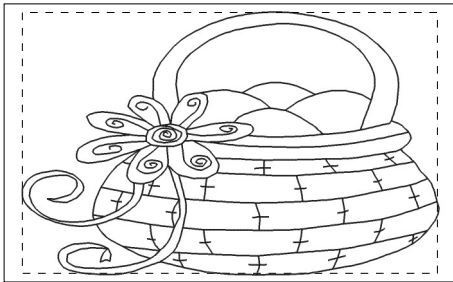

■ 1. Black

Eo837-Bw-03-6x10.pes
9.41x5.91 inches; 8,170 stitches
1 thread changes; 1 colors

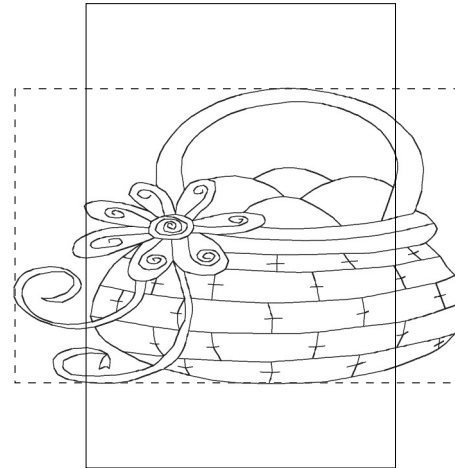

■ 1. Black (Bro:900)

Eo837-Bw-03-8x12.pes
11.48x7.48 inches; 9,926 stitches
1 thread changes; 1 colors

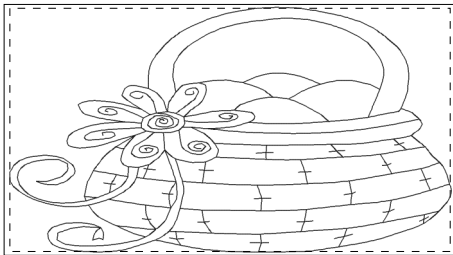

■ 1. Black (Bro:900)

Eo837-Bw-03-8x14.pes
13.80x7.63 inches; 11,406 stitches
1 thread changes; 1 colors

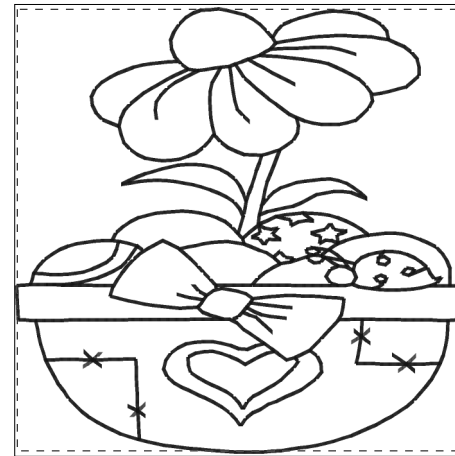

■ 1. Black

Eo837-Bw-04-4x4.pes
3.89x3.85 inches; 3,580 stitches
1 thread changes; 1 colors

Please enjoy this fun set of Easter patterns. They sew out quickly in Bean stitch, I would love a photo of your finished work. They would be pretty in soft pastel variegated threads.

D:\00 SEWING AND EMBROIDERY\00 EMERALD ORIGINALS\000 non golden group sets\00000 EO Sets\EO836-EO837-EASTER BLESSINGS\EO837-BW\EO837-WORKING\EO837-all sizes

Printed 2/10/2020

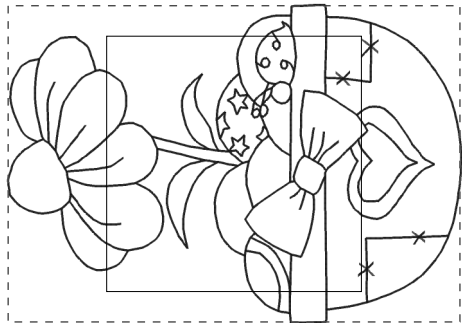

■ 1. Black (Bro:900)

Eo837-Bw-04-5x7 pes
6.97x4.87 inches; 4,920 stitches
1 thread changes; 1 colors

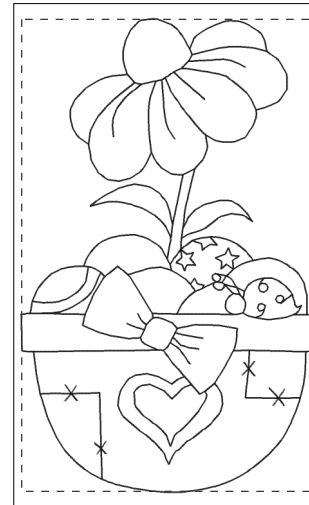

■ 1. Black

Eo837-Bw-04-6x10 pes
5.98x9.60 inches; 6,268 stitches
1 thread changes; 1 colors

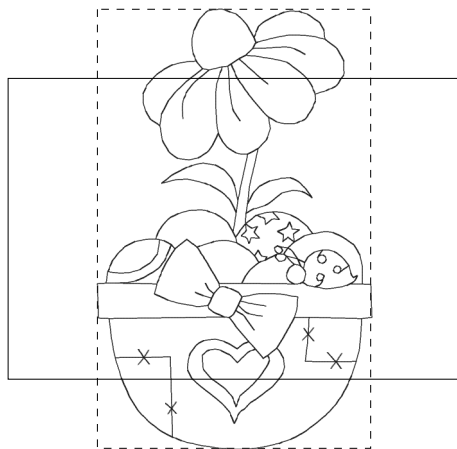

■ 1. Black (Bro:900)

Eo837-Bw-04-8x12 pes
7.15x11.48 inches; 7,406 stitches
1 thread changes; 1 colors

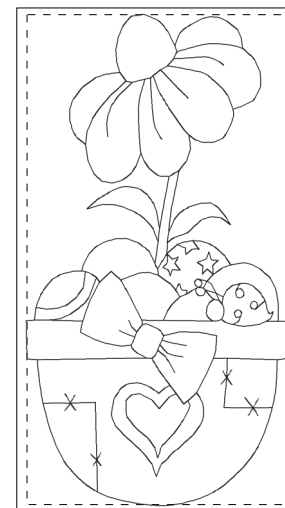

■ 1. Black (Bro:900)

Eo837-Bw-04-8x14 pes
7.30x13.80 inches; 8,137 stitches
1 thread changes; 1 colors

Please enjoy this fun set of Easter patterns. They sew out quickly in Bean stitch, I would love a photo of your finished work. They would be pretty in soft pastel variagated threads.

D:\00 SEWING AND EMBROIDERY\00 EMERALD ORIGINALS\000 non golden group sets\00000 EO Sets\EO836-EO837-EASTER BLESSINGS\EO837-BW\EO837-WORKING\EO837-all sizes

Printed 2/10/2020



■ 1. Black

Eo837-Bw-05-4x4.pes

3.88x3.77 inches; 3,910 stitches
1 thread changes; 1 colors



■ 1. Black

Eo837-Bw-05-5x7.pes

6.51x4.95 inches; 5,534 stitches
1 thread changes; 1 colors



■ 1. Black

Eo837-Bw-05-6x10.pes

9.15x5.91 inches; 7,042 stitches
1 thread changes; 1 colors

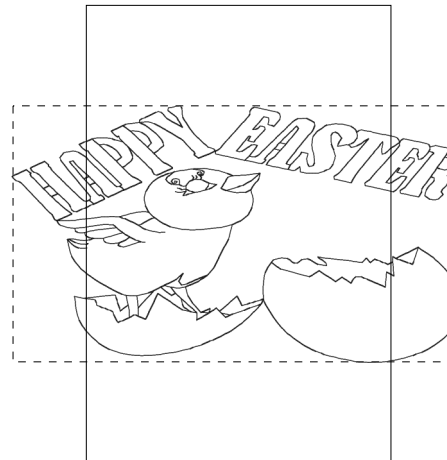

■ 1. Black (Bro:900)

Eo837-Bw-05-8x12.pes

11.67x6.62 inches; 8,374 stitches
1 thread changes; 1 colors

Please enjoy this fun set of Easter patterns. They sew out quickly in Bean stitch, I would love a photo of your finished work. They would be pretty in soft pastel variagated threads.

D:\00 SEWING AND EMBROIDERY\00 EMERALD ORIGINALS\000 non golden group sets\00000 EO Sets\EO836-EO837-EASTER BLESSINGS\EO837-BW\EO837-WORKING\EO837-all sizes

Printed 2/10/2020



■ 1. Black (Bro:900)

Eo837-Bw-05-8x14.pes
13.81x7.83 inches; 9,798 stitches
1 thread changes; 1 colors

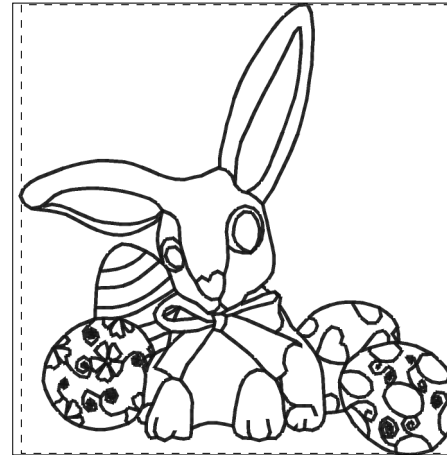

■ 1. Black

Eo837-Bw-06-4x4.pes
3.79x3.91 inches; 4,146 stitches
1 thread changes; 1 colors

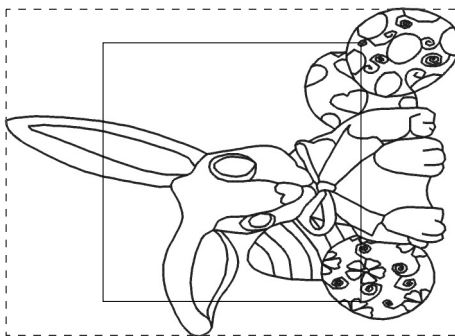

■ 1. Black (Bro:900)

Eo837-Bw-06-5x7.pes
6.88x4.97 inches; 6,042 stitches
1 thread changes; 1 colors

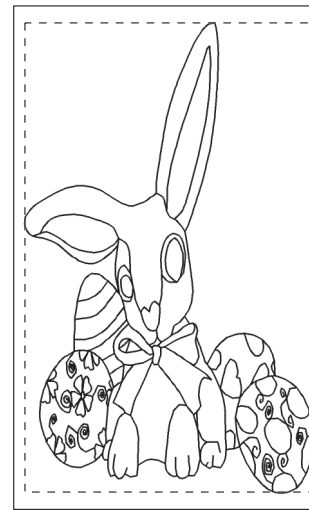

■ 1. Black

Eo837-Bw-06-6x10.pes
5.83x9.54 inches; 7,726 stitches
1 thread changes; 1 colors

Please enjoy this fun set of Easter patterns. They sew out quickly in Bean stitch, I would love a photo of your finished work. They would be pretty in soft pastel variagated threads.

D:\00 SEWING AND EMBROIDERY\00 EMERALD ORIGINALS\000 non golden group sets\00000 EO Sets\EO836-EO837-EASTER BLESSINGS\EO837-BW\EO837-WORKING\EO837-all sizes

Printed 2/10/2020

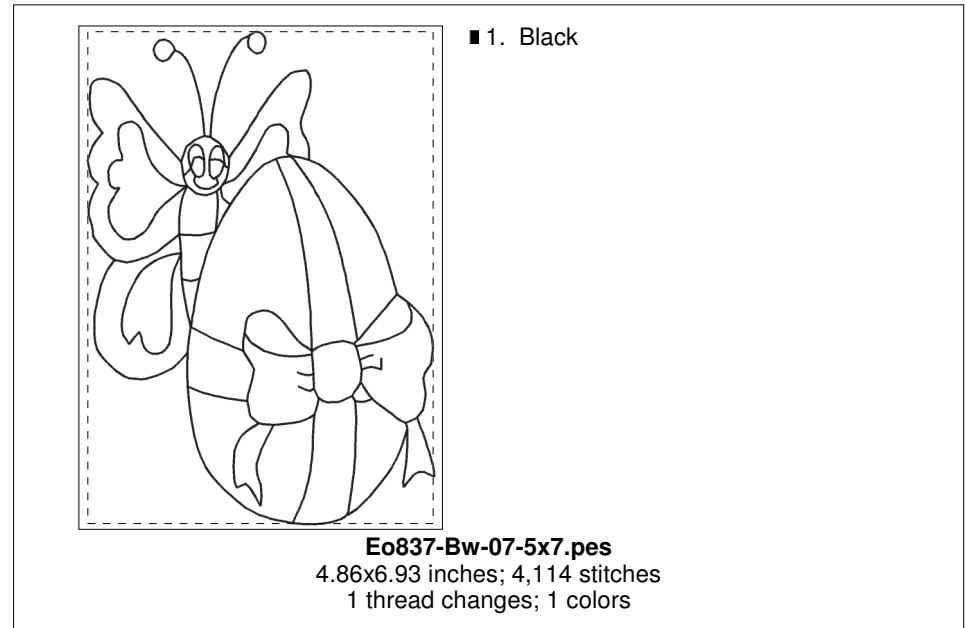
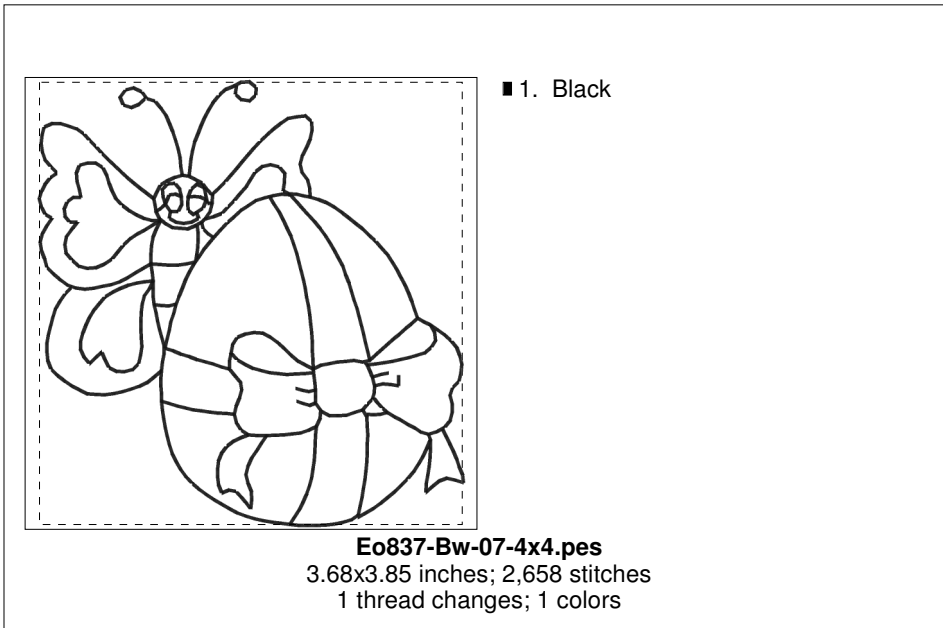
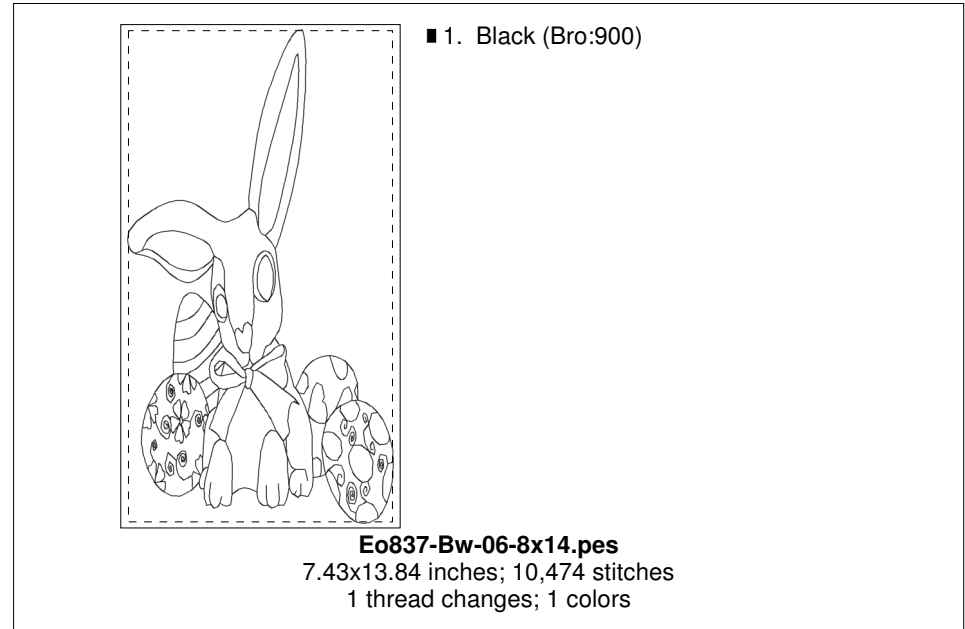
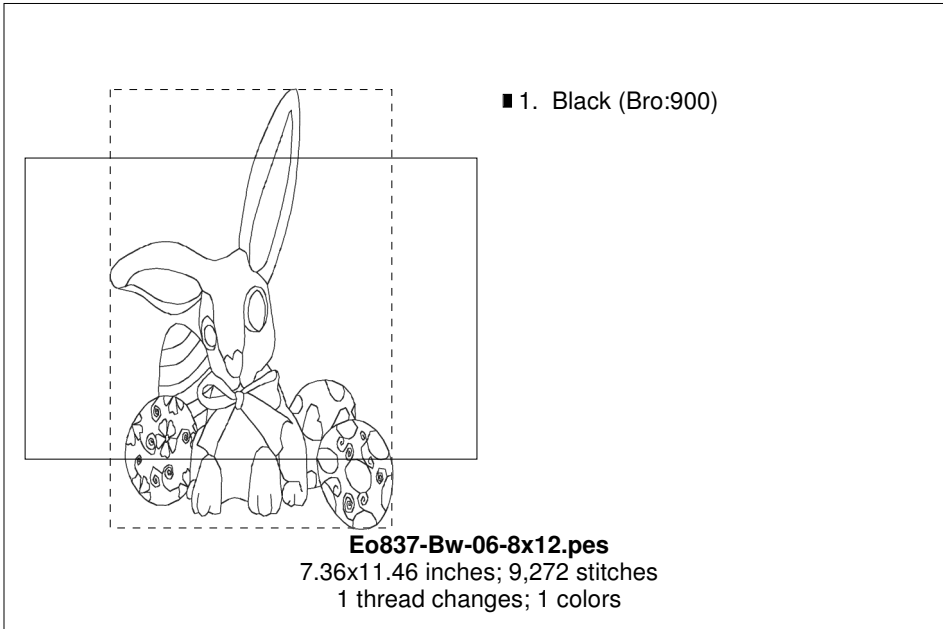

Please enjoy this fun set of Easter patterns. They sew out quickly in Bean stitch, I would love a photo of your finished work. They would be pretty in soft pastel variagated threads.

D:\00 SEWING AND EMBROIDERY\00 EMERALD ORIGINALS\000 non golden group sets\00000 EO Sets\EO836-EO837-EASTER BLESSINGS\EO837-BW\EO837-WORKING\EO837-all sizes

Printed 2/10/2020

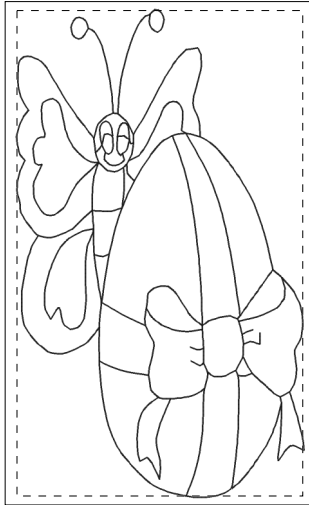

■ 1. Black

Eo837-Bw-07-6x10.pes

5.81x9.87 inches; 5,466 stitches
1 thread changes; 1 colors

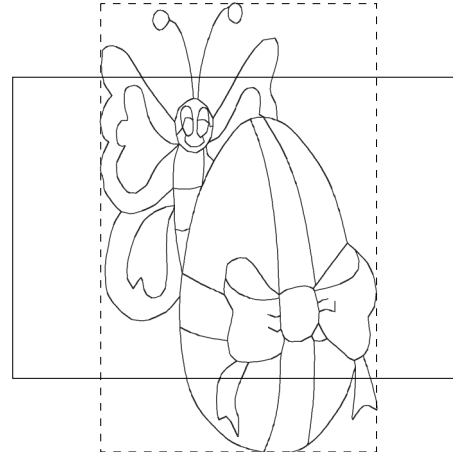

■ 1. Black (Bro:900)

Eo837-Bw-07-8x12.pes

7.22x11.72 inches; 6,542 stitches
1 thread changes; 1 colors

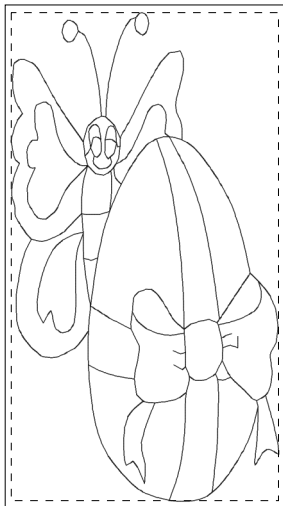

■ 1. Black (Bro:900)

Eo837-Bw-07-8x14.pes

7.52x13.74 inches; 7,411 stitches
1 thread changes; 1 colors

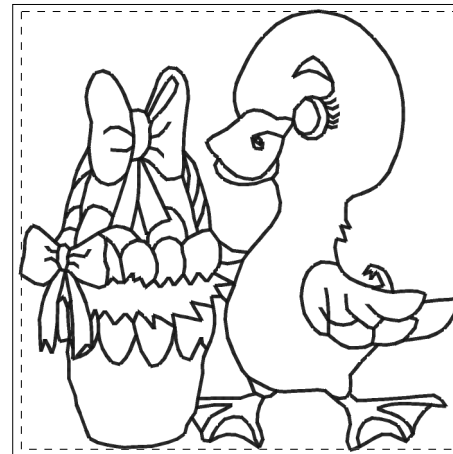

■ 1. Black

Eo837-Bw-08-4x4.pes

3.78x3.81 inches; 3,718 stitches
1 thread changes; 1 colors

Please enjoy this fun set of Easter patterns. They sew out quickly in Bean stitch, I would love a photo of your finished work. They would be pretty in soft pastel variagated threads.

D:\00 SEWING AND EMBROIDERY\00 EMERALD ORIGINALS\000 non golden group sets\00000 EO Sets\EO836-EO837-EASTER BLESSINGS\EO837-BW\EO837-WORKING\EO837-all sizes

Printed 2/10/2020

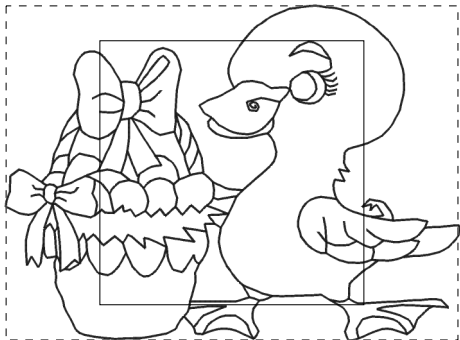

■ 1. Black (Bro:900)

Eo837-Bw-08-5x7.pes

6.74x4.98 inches; 5,398 stitches
1 thread changes; 1 colors

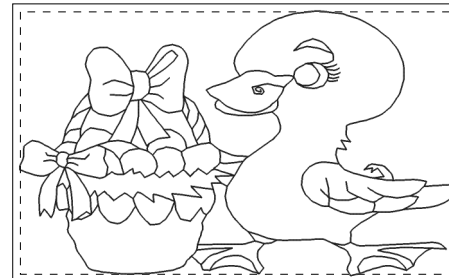

■ 1. Black

Eo837-Bw-08-6x10.pes

9.88x5.95 inches; 7,098 stitches
1 thread changes; 1 colors

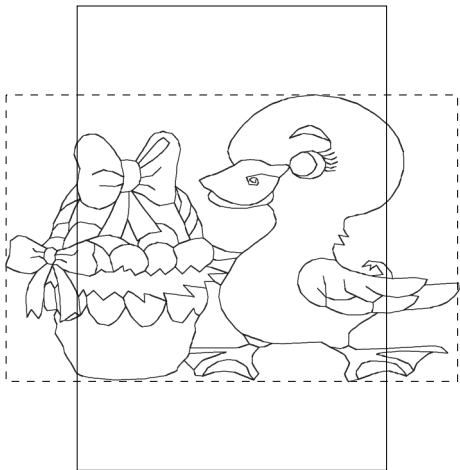

■ 1. Black (Bro:900)

Eo837-Bw-08-8x12.pes

11.49x7.29 inches; 8,331 stitches
1 thread changes; 1 colors



■ 1. Black (Bro:900)

Eo837-Bw-08-8x14.pes

13.71x7.65 inches; 9,374 stitches
1 thread changes; 1 colors

Please enjoy this fun set of Easter patterns. They sew out quickly in Bean stitch, I would love a photo of your finished work. They would be pretty in soft pastel variagated threads.

D:\00 SEWING AND EMBROIDERY\00 EMERALD ORIGINALS\000 non golden group sets\00000 EO Sets\EO836-EO837-EASTER BLESSINGS\EO837-BW\EO837-WORKING\EO837-all sizes

Printed 2/10/2020



■ 1. Black

Eo837-Bw-09-4x4 pes

3.87x3.74 inches; 4,182 stitches
1 thread changes; 1 colors

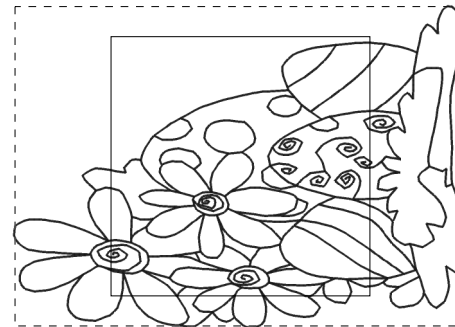

■ 1. Black (Bro:900)

Eo837-Bw-09-5x7 pes

6.86x4.85 inches; 6,258 stitches
1 thread changes; 1 colors

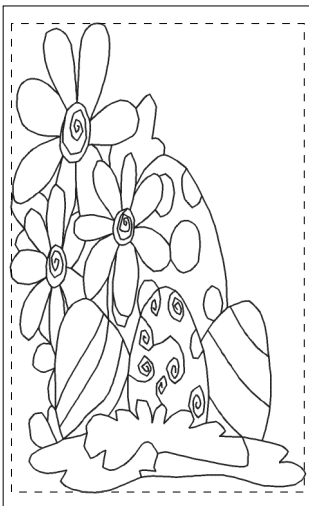

■ 1. Black

Eo837-Bw-09-6x10 pes

5.96x9.53 inches; 8,191 stitches
1 thread changes; 1 colors

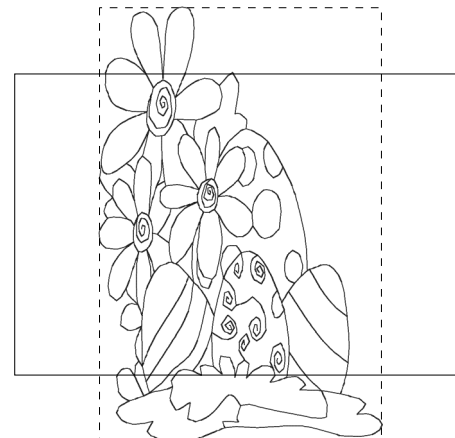

■ 1. Black (Bro:900)

Eo837-Bw-09-8x12 pes

7.37x11.33 inches; 9,799 stitches
1 thread changes; 1 colors

Please enjoy this fun set of Easter patterns. They sew out quickly in Bean stitch, I would love a photo of your finished work. They would be pretty in soft pastel variagated threads.

D:\00 SEWING AND EMBROIDERY\00 EMERALD ORIGINALS\000 non golden group sets\00000 EO Sets\EO836-EO837-EASTER BLESSINGS\EO837-BW\EO837-WORKING\EO837-all sizes

Printed 2/10/2020

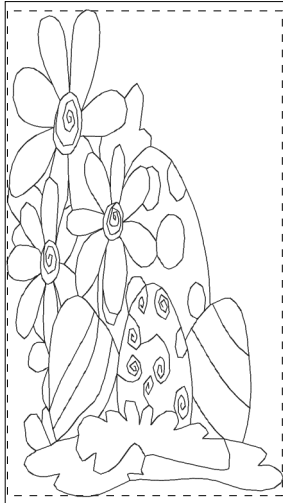

■ 1. Black (Bro:900)

Eo837-Bw-09-8x14.pes

7.75x13.65 inches; 11,199 stitches
1 thread changes; 1 colors

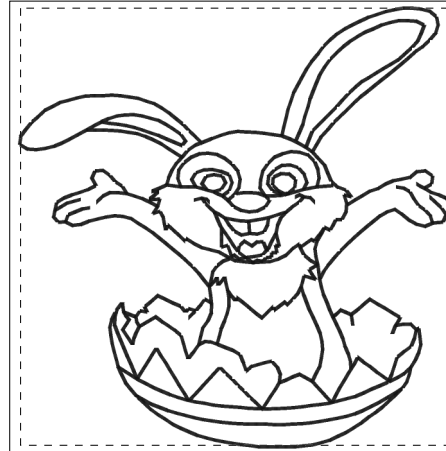

■ 1. Black

Eo837-Bw-10-4x4.pes

3.74x3.81 inches; 3,394 stitches
1 thread changes; 1 colors

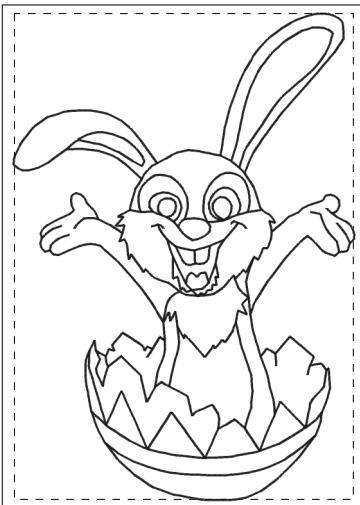

■ 1. Black

Eo837-Bw-10-5x7.pes

4.77x6.84 inches; 4,910 stitches
1 thread changes; 1 colors

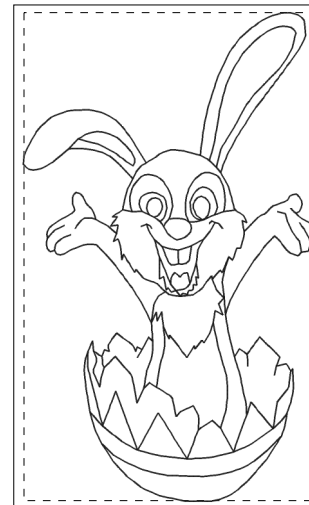

■ 1. Black

Eo837-Bw-10-6x10.pes

5.88x9.92 inches; 6,290 stitches
1 thread changes; 1 colors

Please enjoy this fun set of Easter patterns. They sew out quickly in Bean stitch, I would love a photo of your finished work. They would be pretty in soft pastel variagated threads.

D:\00 SEWING AND EMBROIDERY\00 EMERALD ORIGINALS\000 non golden group sets\00000 EO Sets\EO836-EO837-EASTER BLESSINGS\EO837-BW\EO837-WORKING\EO837-all sizes

Printed 2/10/2020

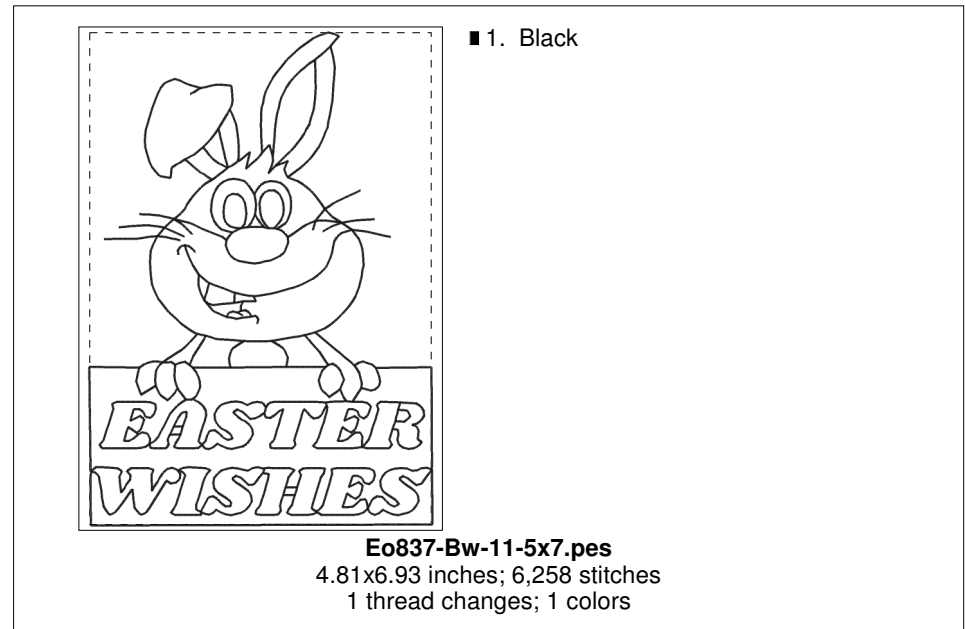
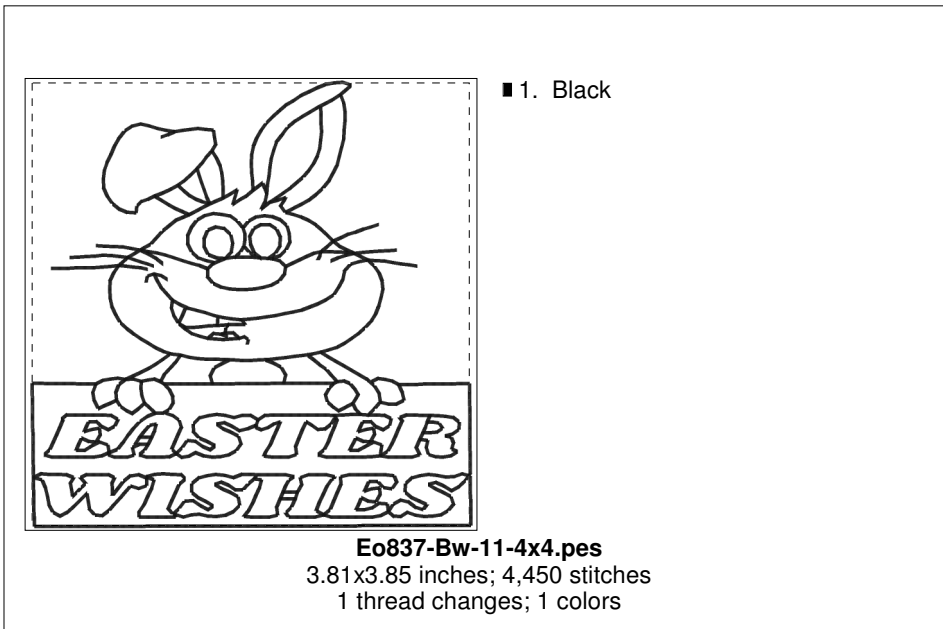
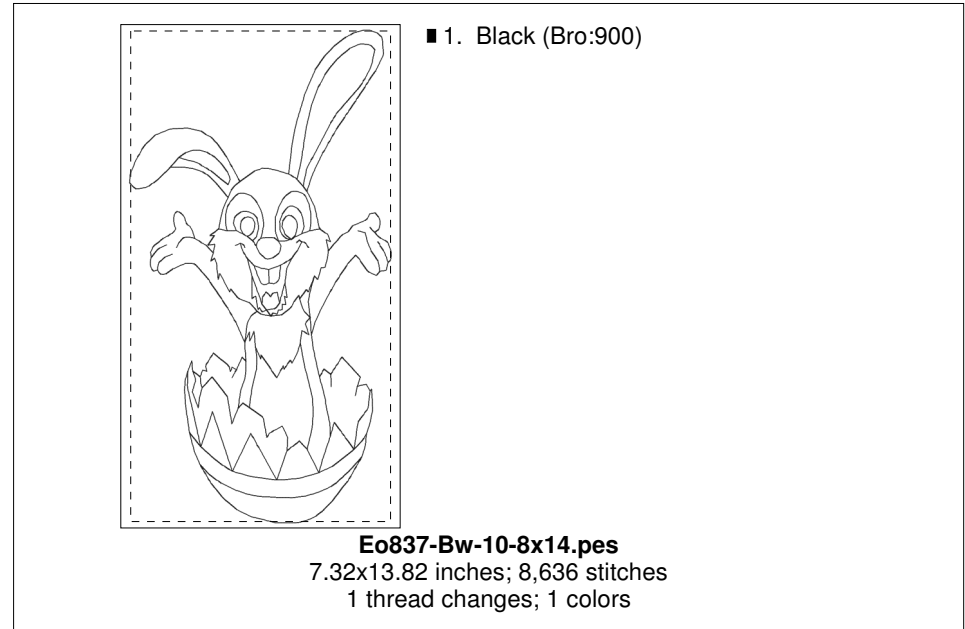
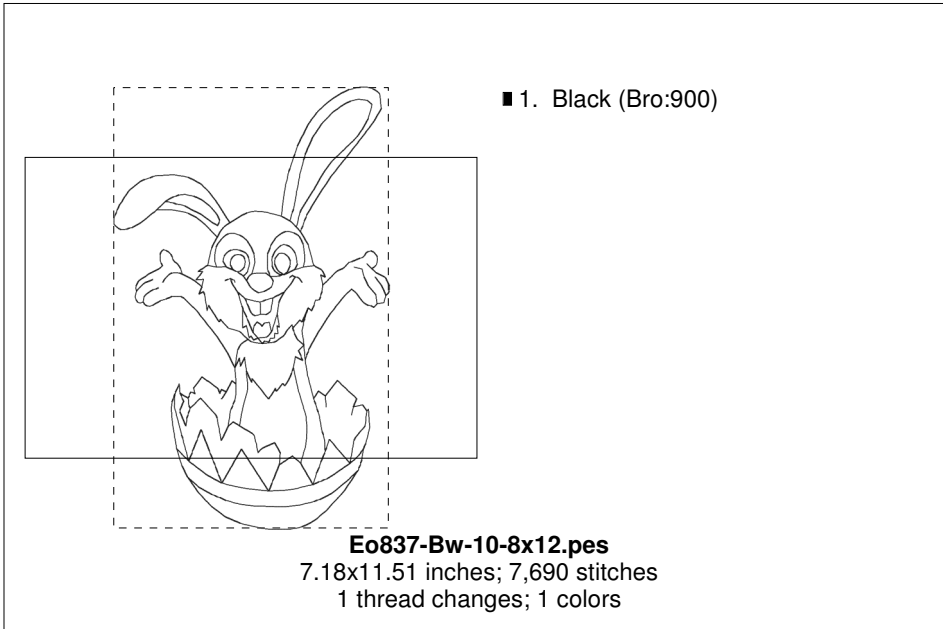

Please enjoy this fun set of Easter patterns. They sew out quickly in Bean stitch, I would love a photo of your finished work. They would be pretty in soft pastel variagated threads.

D:\00 SEWING AND EMBROIDERY\00 EMERALD ORIGINALS\000 non golden group sets\00000 EO Sets\EO836-EO837-EASTER BLESSINGS\EO837-BW\EO837-WORKING\EO837-all sizes

Printed 2/10/2020

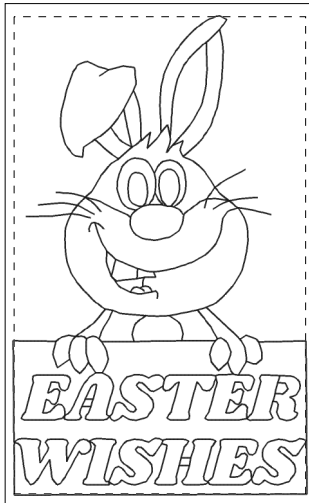

■ 1. Black

Eo837-Bw-11-6x10.pes
5.93x9.71 inches; 8,158 stitches
1 thread changes; 1 colors

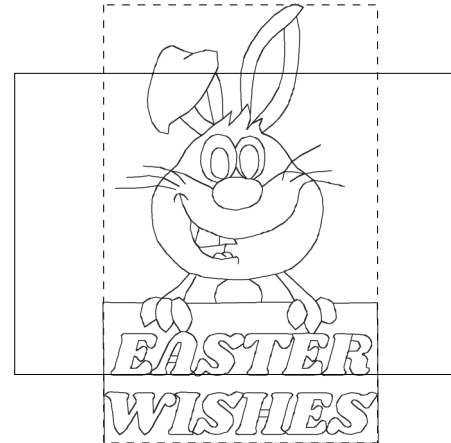

■ 1. Black (Bro:900)

Eo837-Bw-11-8x12.pes
7.17x11.45 inches; 9,622 stitches
1 thread changes; 1 colors

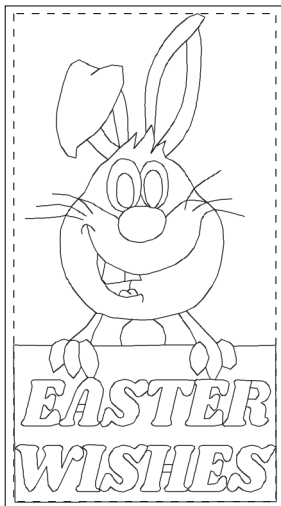

■ 1. Black (Bro:900)

Eo837-Bw-11-8x14.pes
7.38x13.74 inches; 10,730 stitches
1 thread changes; 1 colors

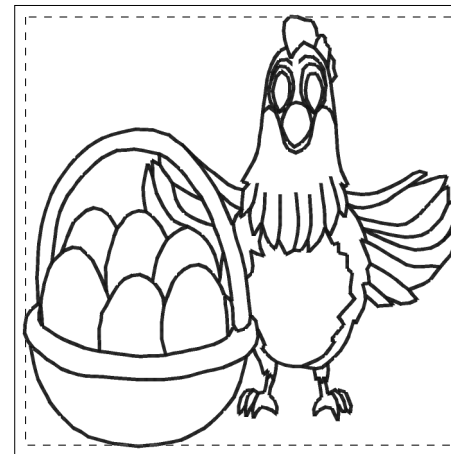

■ 1. Black

Eo837-Bw-12-4x4.pes
3.74x3.73 inches; 3,578 stitches
1 thread changes; 1 colors

Please enjoy this fun set of Easter patterns. They sew out quickly in Bean stitch, I would love a photo of your finished work. They would be pretty in soft pastel variagated threads.

D:\00 SEWING AND EMBROIDERY\00 EMERALD ORIGINALS\000 non golden group sets\00000 EO Sets\EO836-EO837-EASTER BLESSINGS\EO837-BW\EO837-WORKING\EO837-all sizes

Printed 2/10/2020

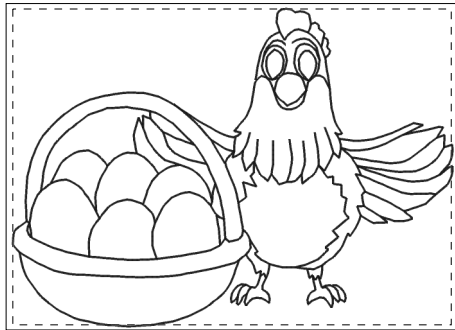

■ 1. Black

Eo837-Bw-12-5x7 pes

6.87x4.96 inches; 5,078 stitches
1 thread changes; 1 colors

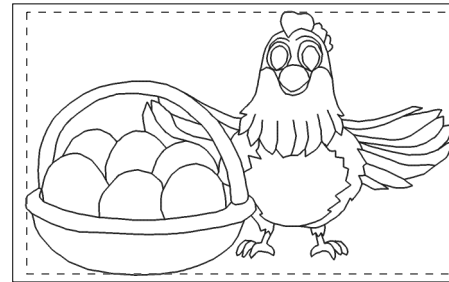

■ 1. Black

Eo837-Bw-12-6x10 pes

9.60x5.93 inches; 6,474 stitches
1 thread changes; 1 colors

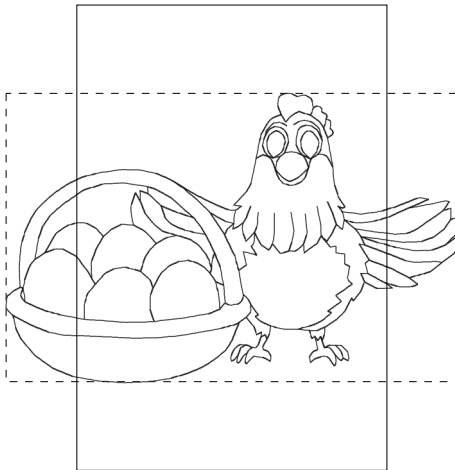

■ 1. Black (Bro:900)

Eo837-Bw-12-8x12 pes

11.46x7.33 inches; 7,754 stitches
1 thread changes; 1 colors

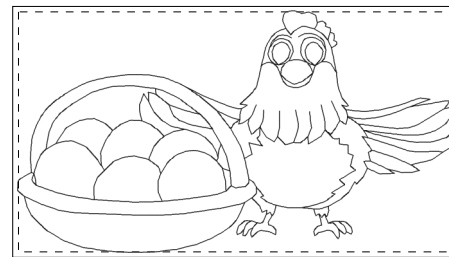

■ 1. Black (Bro:900)

Eo837-Bw-12-8x14 pes

13.82x7.53 inches; 8,746 stitches
1 thread changes; 1 colors

Please enjoy this fun set of Easter patterns. They sew out quickly in Bean stitch, I would love a photo of your finished work. They would be pretty in soft pastel variagated threads.

D:\00 SEWING AND EMBROIDERY\00 EMERALD ORIGINALS\000 non golden group sets\00000 EO Sets\EO836-EO837-EASTER BLESSINGS\EO837-BW\EO837-WORKING\EO837-all sizes

Printed 2/10/2020



■ 1. Black

Eo837-Bw-13-4x4.pes

3.80x3.67 inches; 4,342 stitches
1 thread changes; 1 colors

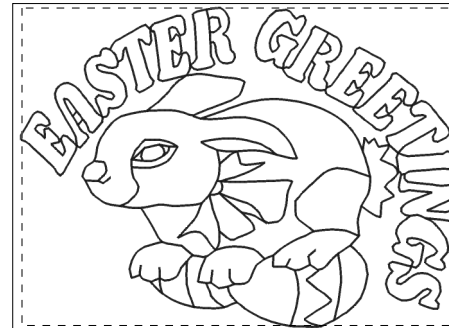

■ 1. Black

Eo837-Bw-13-5x7.pes

6.80x4.98 inches; 6,434 stitches
1 thread changes; 1 colors

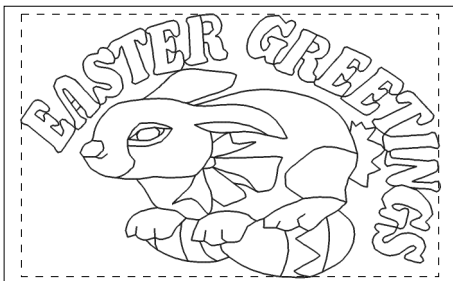

■ 1. Black

Eo837-Bw-13-6x10.pes

9.46x5.94 inches; 8,258 stitches
1 thread changes; 1 colors

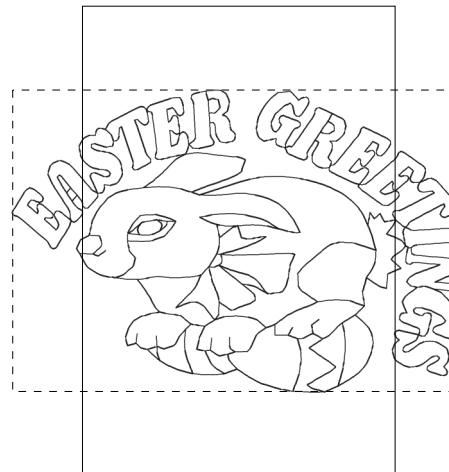

■ 1. Black (Bro:900)

Eo837-Bw-13-8x12.pes

11.37x7.59 inches; 10,114 stitches
1 thread changes; 1 colors

Please enjoy this fun set of Easter patterns. They sew out quickly in Bean stitch, I would love a photo of your finished work. They would be pretty in soft pastel variagated threads.

D:\00 SEWING AND EMBROIDERY\00 EMERALD ORIGINALS\000 non golden group sets\00000 EO Sets\EO836-EO837-EASTER BLESSINGS\EO837-BW\EO837-WORKING\EO837-all sizes

Printed 2/10/2020

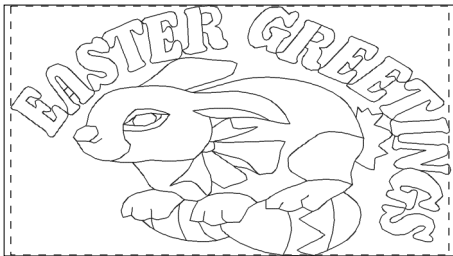

■ 1. Black (Bro:900)

Eo837-Bw-13-8x14.pes
13.74x7.80 inches; 11,378 stitches
1 thread changes; 1 colors

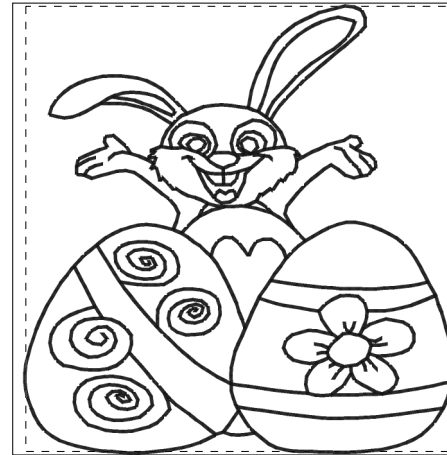

■ 1. Black

Eo837-Bw-14-4x4.pes
3.70x3.88 inches; 3,998 stitches
1 thread changes; 1 colors



■ 1. Black

Eo837-Bw-14-5x7.pes
4.93x6.81 inches; 5,798 stitches
1 thread changes; 1 colors

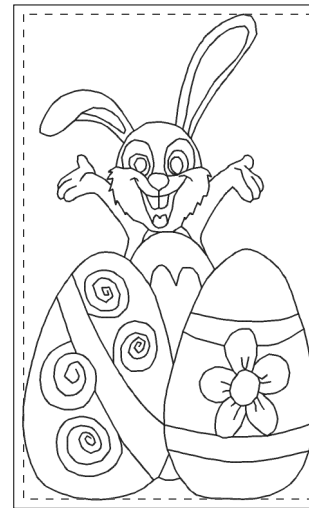

■ 1. Black

Eo837-Bw-14-6x10.pes
5.90x9.86 inches; 7,531 stitches
1 thread changes; 1 colors

Please enjoy this fun set of Easter patterns. They sew out quickly in Bean stitch, I would love a photo of your finished work. They would be pretty in soft pastel variagated threads.

D:\00 SEWING AND EMBROIDERY\00 EMERALD ORIGINALS\000 non golden group sets\00000 EO Sets\EO836-EO837-EASTER BLESSINGS\EO837-BW\EO837-WORKING\EO837-all sizes

Printed 2/10/2020

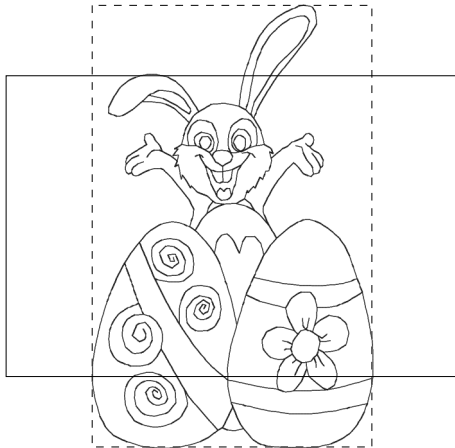

■ 1. Black (Bro:900)

Eo837-Bw-14-8x12.pes

7.31x11.54 inches; 8,995 stitches
1 thread changes; 1 colors

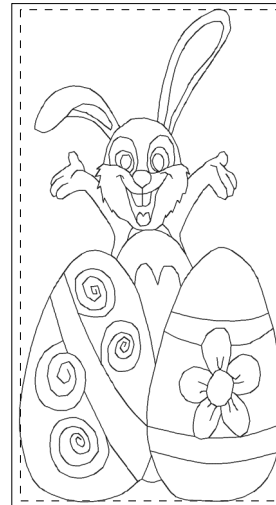

■ 1. Black (Bro:900)

Eo837-Bw-14-8x14.pes

7.39x13.83 inches; 9,947 stitches
1 thread changes; 1 colors



■ 1. Black

Eo837-Bw-15-4x4.pes

3.86x3.90 inches; 5,202 stitches
1 thread changes; 1 colors



■ 1. Black

Eo837-Bw-15-5x7.pes

6.87x4.96 inches; 7,404 stitches
1 thread changes; 1 colors

Please enjoy this fun set of Easter patterns. They sew out quickly in Bean stitch, I would love a photo of your finished work. They would be pretty in soft pastel variagated threads.

D:\00 SEWING AND EMBROIDERY\00 EMERALD ORIGINALS\000 non golden group sets\00000 EO Sets\EO836-EO837-EASTER BLESSINGS\EO837-BW\EO837-WORKING\EO837-all sizes

Printed 2/10/2020



■ 1. Black

Eo837-Bw-15-6x10.pes
9.75x5.94 inches; 9,696 stitches
1 thread changes; 1 colors

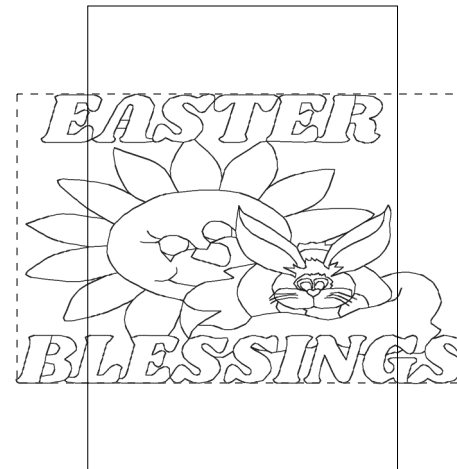

■ 1. Black (Bro:900)

Eo837-Bw-15-8x12.pes
11.47x7.34 inches; 11,472 stitches
1 thread changes; 1 colors



■ 1. Black (Bro:900)

Eo837-Bw-15-8x14.pes
13.85x7.42 inches; 12,847 stitches
1 thread changes; 1 colors

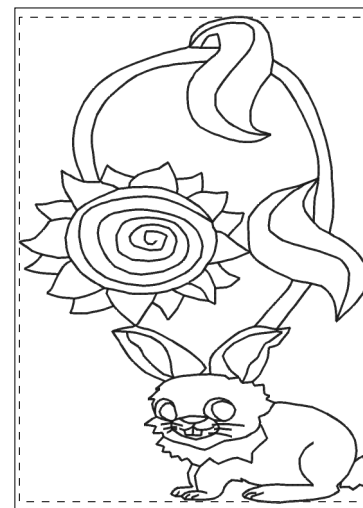

■ 1. Black

Eo837-Bw-16-5x7.pes
4.98x6.82 inches; 5,622 stitches
1 thread changes; 1 colors

Please enjoy this fun set of Easter patterns. They sew out quickly in Bean stitch, I would love a photo of your finished work. They would be pretty in soft pastel variagated threads.

D:\00 SEWING AND EMBROIDERY\00 EMERALD ORIGINALS\000 non golden group sets\00000 EO Sets\EO836-EO837-EASTER BLESSINGS\EO837-BW\EO837-WORKING\EO837-all sizes

Printed 2/10/2020

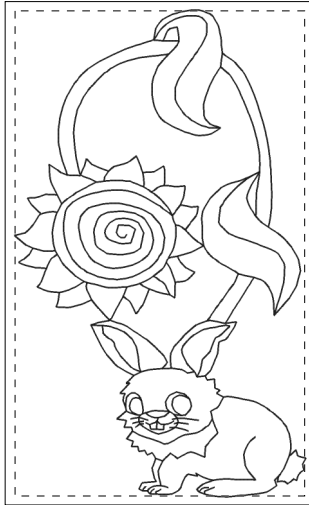

■ 1. Black

Eo837-Bw-16-6x10.pes
5.89x9.87 inches; 7,202 stitches
1 thread changes; 1 colors

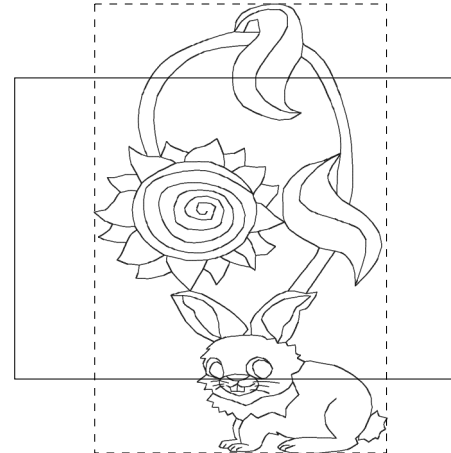

■ 1. Black (Bro:900)

Eo837-Bw-16-8x12.pes
7.64x11.74 inches; 8,810 stitches
1 thread changes; 1 colors

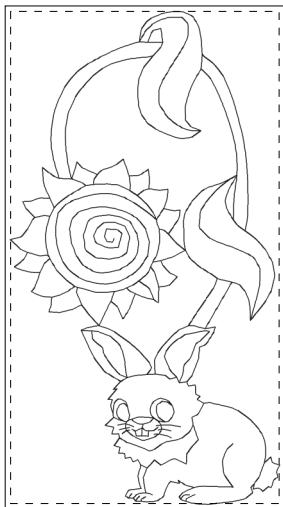

■ 1. Black (Bro:900)

Eo837-Bw-16-8x14.pes
7.57x13.86 inches; 9,495 stitches
1 thread changes; 1 colors

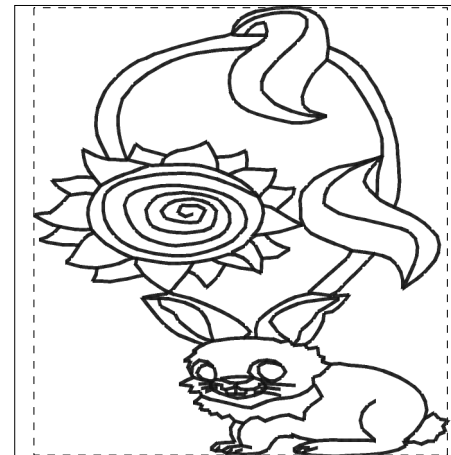

■ 1. Black

Eo837-Bw-16-Free-4x4.pes
3.60x3.90 inches; 3,850 stitches
1 thread changes; 1 colors