

- 1. Placement Line (App:1)
- 2. Cutting Line (App:2)
- 3. Tackdown (App:3)
- 4. Beach Blue (Mar:1063)
- 5. Black (Mar:1180)
- 6. Chrome (Mar:1300)

Lmo1110.art60
122.80x122.50 mm; 17,832 stitches
6 thread changes; 6 colors

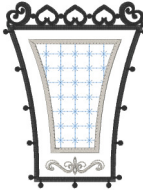

- 1. Placement Line (App:1)
- 2. Cutting Line (App:2)
- 3. Placement Line (App:1)
- 4. Tackdown (App:3)
- 5. Black (Mar:1180)
- 6. Beach Blue (Mar:1063)
- 7. Chrome (Mar:1300)

Lmo1111.art60
126.60x163.90 mm; 12,938 stitches
7 thread changes; 6 colors

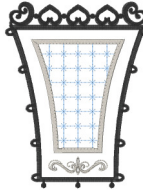

- 1. Placement Line (App:1)
- 2. Cutting Line (App:2)
- 3. Placement Line (App:1)
- 4. Tackdown (App:3)
- 5. Black (Mar:1180)
- 6. Beach Blue (Mar:1063)
- 7. Chrome (Mar:1300)

Lmo1112.art60
127.30x163.80 mm; 13,286 stitches
7 thread changes; 6 colors



- 1. Placement Line (App:1)
- 2. Cutting Line (App:2)
- 3. Black (Mar:1180)
- 4. Chrome (Mar:1300)

Lmo1113.art60
127.30x163.80 mm; 11,991 stitches
4 thread changes; 4 colors

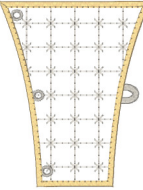

- 1. Placement Line (App:1)
- 2. Cutting Line (App:2)
- 3. Tackdown (App:3)
- 4. Chrome (Mar:1300)
- 5. Cinnamon Sand (Mar:1183)

Lmo1114.art60
79.30x98.40 mm; 4,203 stitches
5 thread changes; 5 colors

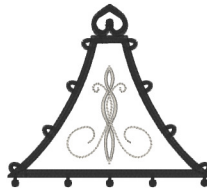

- 1. Placement Line (App:1)
- 2. Cutting Line (App:2)
- 3. Black (Mar:1180)
- 4. Chrome (Mar:1300)

Lmo1115.art60
121.10x108.30 mm; 6,254 stitches
4 thread changes; 4 colors

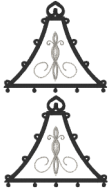

- 1. Placement Line (App:1)
- 2. Cutting Line (App:2)
- 3. Black (Mar:1180)
- 4. Chrome (Mar:1300)

Lmo1115lrg.art60
121.70x220.20 mm; 12,113 stitches
4 thread changes; 4 colors

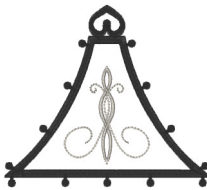

- 1. Placement Line (App:1)
- 2. Cutting Line (App:2)
- 3. Black (Mar:1180)
- 4. Chrome (Mar:1300)

Lmo1116.art60
121.10x108.30 mm; 5,937 stitches
4 thread changes; 4 colors

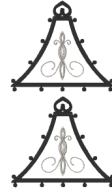

- 1. Placement Line (App:1)
- 2. Cutting Line (App:2)
- 3. Black (Mar:1180)
- 4. Chrome (Mar:1300)

Lmo1116lrg.art60
121.70x223.00 mm; 11,627 stitches
4 thread changes; 4 colors



- 1. Black (Mar:1180)
- 2. Placement Line (App:1)
- 3. Cutting Line (App:2)
- 4. Chrome (Mar:1300)
- 5. Fauve Red (Mar:1194)
- 6. Black (Mar:1180)

Lmo1117.art60
97.90x167.00 mm; 9,777 stitches
6 thread changes; 5 colors

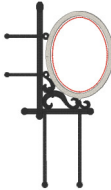

- 1. Black (Mar:1180)
- 2. Placement Line (App:1)
- 3. Cutting Line (App:2)
- 4. Chrome (Mar:1300)
- 5. Fauve Red (Mar:1194)

Lmo1117blank.art60
97.90x167.00 mm; 7,509 stitches
5 thread changes; 5 colors



- 1. Pink (BER:10)
- 2. Placement Line (App:1)
- 3. Summer Citrus (Mar:1007)

Lmo1118.art60
124.90x175.60 mm; 9,577 stitches
3 thread changes; 3 colors



- 1. Lagoon (Mar:1279)

Lmo1119.art60
92.90x124.50 mm; 12,285 stitches
1 thread changes; 1 colors



- 1. Lagoon (Mar:1279)

Lmo1120.art60
67.50x176.10 mm; 17,920 stitches
1 thread changes; 1 colors